

YASKAWA

GA800 Drive

AC Drive for Industrial Applications Installation & Primary Operation

Catalog Code: GA80Uxxxxxxx

200 V class: 0.55 to 110 kW (0.75 to 150 HP)

400 V class: 0.55 to 450 kW (0.75 to 600 HP)

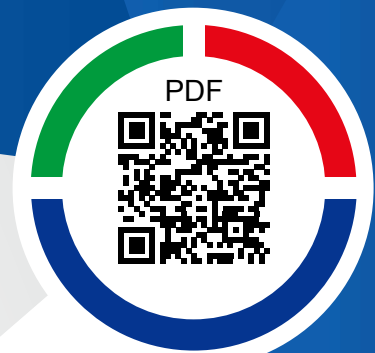

GET IT ON
Google Play

Download on the
App Store

Get the
DriveWizard® Mobile
Commissioning App

<https://www.yaskawa.com/dwm>

This Page Intentionally Blank

Table of Contents

1. General Information	6
2. Safety	6
Explanation of Signal Words	6
General Safety Instructions	6
Exclusion of Liability	8
3. Cybersecurity	8
4. Receiving	8
How to Read Catalog Codes	9
Rated Output Current	10
5. Drive Specifications	11
Area of Use	14
6. Mechanical Installation	14
Moving the Drive	15
Using the Hanging Brackets to Move the Drive	15
Installation Position and Distance	15
Removing/Reattaching Covers	17
Removing/Reattaching the Cover Using Procedure A	17
Removing/Reattaching the Cover Using Procedure B	19
7. Electrical Installation	22
Standard Connection Diagram	22
Main Circuit Terminal Functions	25
Motor and Main Circuit Connections	25
Main Circuit Terminal Block Wiring	26
Wire Selection	26
Main Circuit Terminal Block Wiring Procedure	36
Wiring the Main Circuit Terminal Block Using Procedure A	37
Wiring the Main Circuit Terminal Block Using Procedure B	41
8. Keypad: Names and Functions	43
Keypad Mode and Menu Displays	46
9. LED Status Ring	48

10. Drive Start-Up Procedure	49
Setup Wizard	49
Change Parameter Settings	50
Disable the Initial Setup Screen	52
Control Circuit Terminal Block Functions	52
Input Terminals	53
Output Terminals	54
External Power Supply Input Terminals	55
Serial Communication Terminals	55
Control Circuit Terminal Configuration	55
Control Circuit Wire Gauges and Tightening Torques	56
Wiring the Control Circuit Terminal	57
Switches and Jumpers on the Terminal Board	60
Control I/O Connections	60
Pulse Train Output	60
Set Sinking Mode/Sourcing Mode	61
Set Input Signals for MFAI Terminals A1 to A3	62
Set MFAI Terminal A3 to PTC Input	63
Set Output Signals for MFAO Terminals FM, AM	63
Switch ON Termination Resistor for MEMOBUS/Modbus Communications	64
11. Drive Control, Duty Modes, and Programming	64
Selecting the Control Method	64
Drive Duty Modes	65
Auto-Tuning	65
Drive Parameters	66
12. UL Standards	70
Area of Use	71
Main Circuit Wire Gauges and Tightening Torques	71
Closed-Loop Crimp Terminals	71
Factory-Recommended Branch Circuit Protection for UL Listing	74
200 V Class	74
400 V Class	75
UL Standards Compliance for DC Power Supply Input	76
Low Voltage Wiring for Control Circuit Terminals	77
Drive Motor Overload and Overheat Protection	78
E2-01: Motor Rated Current (FLA)	78
E5-03: PM Motor Rated Current (FLA)	78
E9-06: Motor Rated Current (FLA)	79
L1-01: Motor Overload (oL1) Protection	79
L1-02: Motor Overload Protection Time	82
L1-03: Motor Thermistor oH Alarm Select	83
L1-04: Motor Thermistor oH Fault Select	83
13. European Standards	84
EU Declaration of Conformity	84
CE Low Voltage Directive Compliance	84
Area of Use	84

Guarding against Debris	84
Electrical Installation	84
Main Circuit Wire Gauges and Tightening Torques	86
Connect a Fuse to the Input Side (Primary Side)	95
CE Standards Compliance for DC Power Supply Input	96
14. China RoHS Compliance	99
Information on Hazardous Substances in This Product	99
15. 对应中国RoHS指令	99
本产品中含有有害物质的信息	99
16. Safe Disable Input	100
Safe Disable Specifications	100
Notes	101
Using the Safe Disable Function	101
Safe Disable Circuit	101
Enabling and Disabling the Drive Output ("Safe Torque Off")	102
Safe Disable Monitor Output Function and Keypad Display	103
Validating the Safe Disable Function	103
17. Disposal and Environmental Compatibility	104
18. Maintenance	104
19. Troubleshooting	104
Faults	105
Minor Faults/Alarms	114
Parameter Setting Errors	118
Auto-Tuning Errors	120
Backup Function Operating Mode Display and Errors	123
Revision History	124

1 General Information

The products and specifications given in this manual and the manual contents can change without notice to make the product and manual better.

Be sure to always use the latest version of this manual. Use this manual to correctly install, wire, set, and operate this product.

Users can download additional manuals for this product from the Yaskawa documentation website printed on the back cover.

2 Safety

Read the safety instructions carefully before you install, wire, or operate this product.

◆ Explanation of Signal Words

▲ DANGER This signal word identifies a hazard that will cause serious injury or death if you do not prevent it.

▲ WARNING This signal word identifies a hazard that can cause death or serious injuries if you do not prevent it.

▲ CAUTION Identifies a hazardous situation, which, if not avoided, can cause minor or moderate injury.

NOTICE This signal word identifies a property damage message that is not related to personal injury.

◆ General Safety Instructions

Yaskawa Electric manufactures and supplies electronic components for a variety of industrial applications. The selection and application of Yaskawa products is the responsibility of the designer of the equipment or the customer who assembles the final product. Yaskawa is not responsible for how our products are incorporated into the final system design. In all cases, Yaskawa products should not be incorporated into a product or design as the exclusive or sole safety control function. All control functions are designed to dynamically detect failures and operate safely without exception. All products that are designed to incorporate parts manufactured by Yaskawa must be provided to the end user and include proper warnings and instructions regarding their safe use and operation. All warnings from Yaskawa must be promptly issued to the end user. Yaskawa offers warranties only for the quality of our products, in compliance with standards and specifications that are described in the manual. Yaskawa does not offer other warranties, either explicit or implied. Injuries, property damage, and lost business opportunities caused by improper storage or handling and negligence oversight on the part of your company or your customers will void Yaskawa's warranty for the product.

Note:

If you do not obey the safety messages in the manual, you are at risk for serious injury or death. Yaskawa is not responsible for injuries or damage to equipment if you ignore the safety messages.

- Read this manual carefully when you install, operate, or repair AC drives.
- Obey all warnings, cautions, and notices.
- Approved personnel must do all work.
- Install the drive as specified by this manual and local codes.

▲ DANGER *Electrical Shock Hazard. Do not examine, connect, or disconnect wiring on an energized drive. Before servicing, disconnect all power to the equipment and wait for the time specified on the warning label at a minimum. The internal capacitor stays charged after the drive is de-energized. The charge indicator LED extinguishes when the DC bus voltage decreases below 50 Vdc. When all indicators are OFF, remove the covers before measuring for dangerous voltages to make sure that the drive is safe. If you do work on the drive when it is energized, it will cause serious injury or death from electrical shock. The drive has internal capacitors that stay charged after you de-energize the drive.*

▲ DANGER *Fire Hazard. Do not connect main power supply wiring to drive motor terminals U/T1, V/T2, and W/T3. Connect main power supply wiring to main circuit input terminals R/L1, S/L2, and T/L3. Incorrect wiring can cause serious injury or death from fire.*

▲ WARNING *Electrical Shock Hazard. Do not modify the drive body or drive circuitry. Modifications to drive body and circuitry can cause serious injury or death, will cause damage to the drive, and will void the warranty. Yaskawa is not responsible for modifications of the product made by the user.*

- ⚠ WARNING** *Crush Hazard. Only approved personnel can operate a crane or hoist to move the drive. If unapproved personnel operate a crane or hoist, it can cause serious injury or death from falling equipment.*
- ⚠ WARNING** *Electrical Shock Hazard. Only let approved personnel install, wire, maintain, examine, replace parts, and repair the drive. If personnel are not approved, it can cause serious injury or death.*
- ⚠ WARNING** *Electrical Shock Hazard. Always ground the motor-side grounding terminal. If you do not ground the equipment correctly, it can cause serious injury or death if you touch the motor case.*
- ⚠ WARNING** *Electrical Shock Hazard. Do not wear loose clothing or jewelry when you do work on the drive. Tighten loose clothing and remove all metal objects, for example watches or rings. Loose clothing can catch on the drive and jewelry can conduct electricity and cause serious injury or death.*
- ⚠ WARNING** *Sudden Movement Hazard. Before you do Auto-Tuning, remove all personnel and objects from the area around the drive, motor, and load. The drive and motor can start suddenly during Auto-Tuning and cause serious injury or death.*
- ⚠ WARNING** *Sudden Movement Hazard. Remove all personnel and objects from the area around the drive, motor, and machine and attach covers, couplings, shaft keys, and machine loads before you energize the drive. If personnel are too close or if there are missing parts, it can cause serious injury or death.*
- ⚠ WARNING** *Fire Hazard. Do not use the main circuit power supply (Overvoltage Category III) at incorrect voltages. Operate the drive in the specification range of the input voltage on the drive nameplate. Voltages that are higher than the permitted nameplate tolerance can cause damage to the drive.*
- ⚠ WARNING** *Fire Hazard. Do not put flammable or combustible materials on top of the drive and do not install the drive near flammable or combustible materials. Attach the drive to metal or other noncombustible material. Flammable and combustible materials can start a fire and cause serious injury or death.*
- ⚠ WARNING** *Fire Hazard. Tighten all terminal screws to the correct tightening torque. Connections that are too loose or too tight can cause incorrect operation and damage to the drive. Incorrect connections can also cause death or serious injury from fire.*
- ⚠ WARNING** *Fire Hazard. Tighten screws at an angle in the specified range shown in this manual. If you tighten the screws at an angle not in the specified range, you can have loose connections that can cause damage to the terminal block or start a fire and cause serious injury or death.*
- ⚠ WARNING** *Crush Hazard. Use a crane or hoist to move large drives when necessary. If you try to move a large drive without a crane or hoist, it can cause serious injury or death.*
- ⚠ WARNING** *Electrical Shock Hazard. Do not cause a short circuit on the drive output circuit. A short circuit on the output can cause serious injury or death.*
- ⚠ WARNING** *Electrical Shock Hazard. When a residual current operated protective or monitoring device prevents direct or indirect contact, always use a type B Ground Fault Circuit Interrupter (GFCI) as specified by IEC/EN 60755. If you do not use the correct GFCI, it can cause serious injury or death. The drive can cause a residual current with a DC component in the protective earthing conductor.*
- ⚠ WARNING** *Crush Hazard. Test the system to make sure that the drive operates safely after you wire the drive and set parameters. If you do not test the system, it can cause damage to equipment or serious injury or death.*
- ⚠ WARNING** *Electrical Shock Hazard. After the drive blows a fuse or trips a GFCI, do not immediately energize the drive or operate peripheral devices. Wait for the time specified on the warning label at a minimum and make sure that all indicators are OFF. Then check the wiring and peripheral device ratings to find the cause of the problem. If you do not know the cause of the problem, contact Yaskawa before you energize the drive or peripheral devices. If you do not fix the problem before you operate the drive or peripheral devices, it can cause serious injury or death.*
- ⚠ WARNING** *Crush Hazard. Only approved personnel can operate a crane or hoist to move the drive. If unapproved personnel operate a crane or hoist, it can cause serious injury or death from falling equipment.*
- ⚠ WARNING** *Arc Flash Hazard. It is possible that there is more than one source of power for equipment. Obey the requirements for Electrical Safety in the Workplace and local codes for safe work procedures and applicable personal protective equipment (PPE). Failure to obey can cause serious injury or death.*
- ⚠ CAUTION** *Crush Hazard. Tighten terminal cover screws and hold the case safely when you move the drive. If the drive or covers fall, it can cause moderate injury.*
- ⚠ CAUTION** *Burn Hazard. Do not touch a hot drive heatsink. De-energize the drive, wait for a minimum of 15 minutes, then make sure that the heatsink is cool before you replace the cooling fans. If you touch a hot drive heatsink, it can burn you.*
- NOTICE** *Fire Hazard. Install sufficient branch circuit short circuit protection as specified by applicable codes and this manual. The drive is suited for circuits that supply not more than 100,000 RMS symmetrical amperes, 240 Vac maximum (200 V Class), 480 Vac maximum (400 V Class). Incorrect branch circuit short circuit protection can cause serious injury or death.*

NOTICE When you touch the drive and circuit boards, make sure that you observe correct electrostatic discharge (ESD) procedures. If you do not follow procedures, it can cause ESD damage to the drive circuitry.

NOTICE Do not break the electrical connection between the drive and the motor when the drive is outputting voltage. Incorrect equipment sequencing can cause damage to the drive.

NOTICE Do not do a withstand voltage test or use a Megger insulation tester on the drive. These tests can cause damage to the drive.

NOTICE Do not operate a drive or connected equipment that has damaged or missing parts. You can cause damage to the drive and connected equipment.

NOTICE Install branch circuit protection, for example fuses or ground fault circuit interrupters (GFCIs) as specified in the drive instructions. If you do not install these components, it can cause damage to the drive and connected equipment.

NOTICE Do not use unshielded wire for control wiring. Use shielded, twisted-pair wires and ground the shield to the ground terminal of the drive. Unshielded wire can cause electrical interference and unsatisfactory system performance.

NOTICE Before you connect a dynamic braking option to the drive, make sure that qualified personnel read and obey the Braking Unit and Braking Resistor Unit Installation Manual (TOBPC72060001). If you do not read and obey the manual or if personnel are not qualified it can cause damage to the drive and braking circuit.

NOTICE Do not modify the drive body or drive circuitry. Changes to drive body and circuitry can cause serious injury or death, will cause damage to the drive, and will void the warranty. Yaskawa is not responsible for modifications of the product made by the user.

NOTICE Make sure that all connections are correct after you install the drive and connect peripheral devices. Incorrect connections can cause damage to the drive.

NOTICE Use the drive ground wire to ground the drive only. Do not try to use the drive ground wire for other devices, for example welding machines or large-current electrical equipment.

NOTICE Use an inverter-duty motor or vector-duty motor with reinforced insulation and windings applicable for use with an AC drive. If the motor does not have the correct insulation, it can cause a short circuit or ground fault from insulation deterioration.

◆ Exclusion of Liability

- This product is not designed and manufactured for use in life-support machines or systems.
- Contact a Yaskawa representative or your Yaskawa sales representative if you are considering the application of this product for special purposes, such as machines or systems used for passenger cars, medicine, airplanes and aerospace, nuclear power, electric power, or undersea relaying.

⚠ WARNING Injury to Personnel. When you use this product in applications where its failure could cause the loss of human life, a serious accident, or physical injury, you must install applicable safety devices. If you do not correctly install safety devices, it can cause serious injury or death.

3 Cybersecurity

This product is designed to connect and communicate information and data through a network interface. It is the sole responsibility of the customer to provide and continuously guarantee a secure connection between the product and the customer's network or if applicable, any other network. The customer must establish and maintain the appropriate measures (such as, but not limited to, the installation of firewalls, the application of authentication measures, the encryption of data, the installation of antivirus programs, etc.) to protect the product, the network, its system and the interface against all types of security breaches, unauthorized access, interference, intrusion, leakage and/or theft of data or information. Yaskawa and its affiliates are not responsible for damages and/or losses related to such security breaches, any unauthorized access, interference, intrusion, leakage and/or theft of data or information.

4 Receiving

1. Inspect the product for damage and missing parts. Immediately contact the shipping company if the drive is damaged. The Yaskawa warranty does not cover damage from shipping.
2. Check the catalog code in the "C/C" section of the drive nameplate to make sure that you received the correct model.
3. If you did not receive the correct drive or if your drive does not operate correctly, contact your supplier.
4. Check drive and motor compatibility for systems with more than one drive.

NOTICE Damage to Equipment. Do not install or use damaged parts or damaged motors into the drive system.

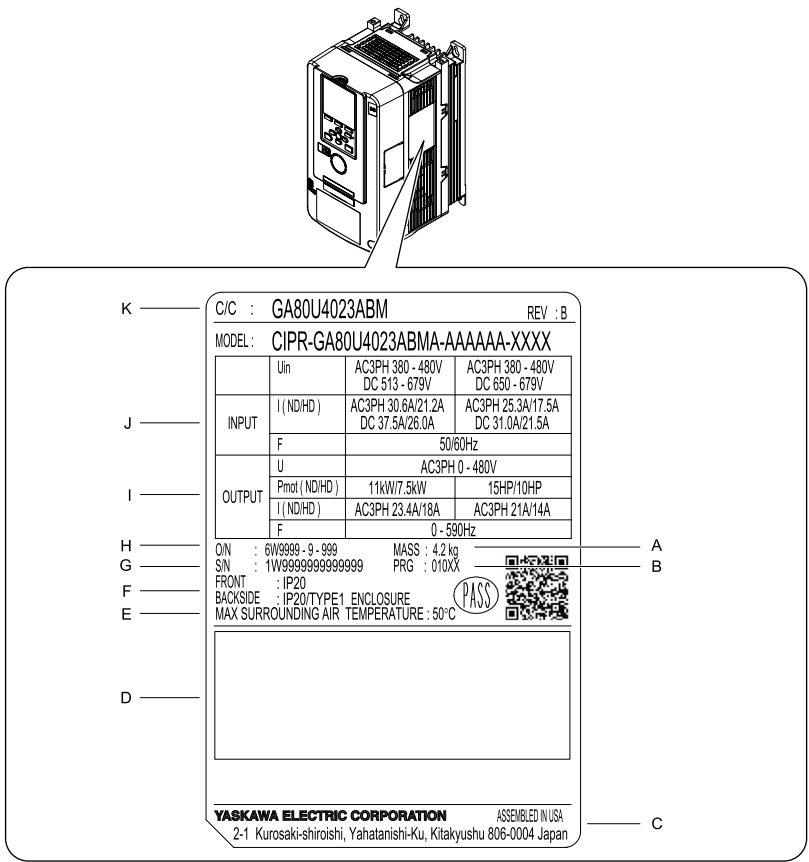

- A - Mass
- B - Drive software version
- C - The address of the head office of Yaskawa Electric Corporation
- D - Standards compliance
- E - Surrounding air temperature
- F - Enclosure protection design
- G - Serial number
- H - Lot number
- I - Output specifications
- J - Input specifications
- K - Catalog code

Figure 4.1 Nameplate Example

◆ How to Read Catalog Codes

Use the information in Figure 4.2 and Table 4.1 to read the drive catalog codes.

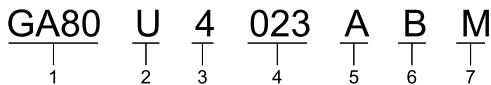

Figure 4.2 Drive Catalog Code

Table 4.1 Catalog Code Details

No.	Description
1	GA800 Series
2	Region code • U: Americas
3	Input power supply voltage • 2: Three-Phase AC 240 V • 4: Three-Phase AC 480 V

4 Receiving

No.	Description
4	Rated output current Note: Refer to the rated output current list for more information.
5	EMC noise filter A: No built-in EMC filter
6	Protection design B: IP20 W: Flange (Type 12 Backside)
7	Environmental specification M: Resistant to dust/humidity

■ Rated Output Current

Refer to [Table 4.2](#) to [Table 4.3](#) for rated output current values.

Note:

- These output current values apply to drives that operate at standard specifications.
- Derate the output current for applications that require:
 - Higher carrier frequencies
 - Ambient temperature beyond nameplate ratings
 - Drives installed side-by-side.
- Use C6-01 [*Normal / Heavy Duty Selection*] to select Normal Duty rating (ND) or Heavy Duty rating (HD).

Table 4.2 Output Current for Three-Phase AC 240 V Models

Model	Heavy Duty Rating (HD) Parameter C6-01 = 0		Normal Duty Rating (ND) Parameter C6-01 = 1 (Default)	
	Maximum Motor Output kW (HP)	Rated Output Current A	Maximum Motor Output kW (HP)	Rated Output Current A
2004	0.55 (.75)	3.5	0.75 (1)	4.2
2006	0.75 (1)	5	1.1 (1.5)	6
2008	1.1 (1.5)	6.9	1.5 (2)	8
2010	1.5 (2)	8	2.2 (3)	9.6
2012	2.2 (3)	11	3 (4)	12.2
2018	3 (4)	14	3.7 (5)	17.5
2021	3.7 (5)	17.5	5.5 (7.5)	21
2030	5.5 (7.5)	25	7.5 (10)	30
2042	7.5 (10)	33	11 (15)	42
2056	11 (15)	47	15 (20)	56
2070	15 (20)	60	18.5 (25)	70
2082	18.5 (25)	75	22 (30)	82
2110	22 (30)	88	30 (40)	110
2138	30 (40)	115	37 (50)	138
2169	37 (50)	145	45 (60)	169
2211	45 (60)	180	55 (75)	211
2257	55 (75)	215	75 (100)	257
2313	75 (100)	283	90 (125)	313
2360	90 (125)	346	110 (150)	360
2415	110 (150)	415	110 (150)	415

Table 4.3 Output Current for Three-Phase 480 V Models

Model	Heavy Duty Rating (HD) Parameter C6-01 = 0		Normal Duty Rating (ND) Parameter C6-01 = 1 (Default)	
	Maximum Motor Output kW (HP)	Rated Output Current A	Maximum Motor Output kW (HP)	Rated Output Current A
4002	0.55 (0.75)	1.8	0.75 (1)	2.1
4004	1.1 (1.5)	3.4	1.5 (2)	4.1
4005	1.5 (2)	4.8	2.2 (3)	5.4
4007	2.2 (3)	5.5	3 (4)	7.1
4009	3.0 (4)	7.2	3.7 (5)	8.9
4012	3.7 (5)	9.2	5.5 (7.5)	11.9
4018	5.5 (7.5)	14.8	7.5 (10)	17.5
4023	7.5 (10)	18	11 (15)	23.4
4031	11 (15)	24	15 (20)	31
4038	15 (20)	31	18.5 (25)	38
4044	18.5 (25)	39	22 (30)	44
4060	22 (30)	45	30 (40)	59.6
4075	30 (40)	60	37 (50)	74.9
4089	37 (50)	75	45 (60)	89.2
4103	45 (60)	91	55 (75)	103
4140	55 (75)	112	75 (100)	140
4168	75 (100)	150	90 (125)	168
4208	90 (125)	180	110 (150)	208
4250	110 (150)	216	150 (200)	250
4302	150 (200)	260	185 (250)	302
4371	185 (250)	304	220 (300)	371
4414	220 (300)	371	260 (350)	414
4477	260 (350)	414	300 (400)	477
4568	300 (400)	477	335 (450)	568
4605	335 (450)	605	370 (500)	675
4720	370 (500)	605	450 (600)	720

5 Drive Specifications

Table 5.1 Control Characteristics

Item	Specification
Control Methods	<ul style="list-style-type: none"> • V/f Control (V/f) • V/f Control with Encoder (CL-V/f) • Open Loop Vector (OLV) • Closed Loop Vector (CLV) • Advanced Open Loop Vector (AOLV) • PM Open Loop Vector (OLV/PM) • PM Advanced Open Loop Vector (AOLV/PM) • PM Closed Loop Vector (CLV/PM) • EZ Vector Control (EZOLV)
Frequency Control Range	<ul style="list-style-type: none"> • AOLV and EZOLV: 0.01 Hz to 120 Hz • CL-V/f, CLV, AOLV/PM, and CLV/PM: 0.01 Hz to 400 Hz • V/f, OLV, and OLV/PM: 0.01 Hz to 590 Hz

5 Drive Specifications

Item	Specification
Frequency Accuracy (Temperature Fluctuation)	Digital inputs: Within $\pm 0.01\%$ of the maximum output frequency (-10 °C to +40 °C (14 °F to 104 °F)) Analog inputs: Within $\pm 0.1\%$ of the maximum output frequency (25 °C \pm 10 °C (77 °F \pm 18 °F))
Frequency Setting Resolution	Digital inputs: 0.01 Hz Analog inputs: 1/2048 of the maximum output frequency (11-bit signed)
Output Frequency Resolution	0.001 Hz
Frequency Setting Signal	Main speed frequency reference: -10 Vdc to +10 Vdc (20 k Ω), 0 Vdc to 10 Vdc (20 k Ω), 4 mA to 20 mA (250 Ω), 0 mA to 20 mA (250 Ω) Main speed reference: Pulse train input (maximum 32 kHz)
Starting Torque	<ul style="list-style-type: none"> • V/f: 150%/3 Hz • CL-V/f: 150%/3 Hz • OLV: 200%/0.3 Hz • CLV: 200%/0 min⁻¹ (r/min) • AOLV: 200%/0.3 Hz • OLV/PM: 100%/5% speed • AOLV/PM: 200%/0 min⁻¹ (r/min) • CLV/PM: 200%/0 min⁻¹ (r/min) • EZOLV: 100%/1% speed <p>Note: Correctly select the drive and motor capacity for this starting torque in these control methods:</p> <ul style="list-style-type: none"> • OLV • CLV • AOLV • AOLV/PM • CLV/PM
Speed Control Range	<ul style="list-style-type: none"> • V/f: 1:40 • CL-V/f: 1:40 • OLV: 1:200 • CLV: 1:1500 • AOLV: 1:200 • OLV/PM: 1:20 • AOLV/PM: 1:100 (when high frequency injection is enabled) • CLV/PM: 1:1500 • EZOLV: 1:100
Zero Speed Control	Possible in these control methods: <ul style="list-style-type: none"> • CLV • AOLV/PM • CLV/PM
Torque Limits	Parameter settings allow different limits in four quadrants in these control methods: <ul style="list-style-type: none"> • OLV • CLV • AOLV • AOLV/PM • CLV/PM • EZOLV
Accel/Decel Time	0.0 s to 6000.0 s The drive can set four pairs of different acceleration and deceleration times.

Item	Specification
Braking Torque	<p>Approximately 20%</p> <p>Approximately 125% with a dynamic braking option</p> <ul style="list-style-type: none"> Short-time average deceleration torque <ul style="list-style-type: none"> Motor output 0.4/0.75 kW: over 100% Motor output 1.5 kW: over 50% Motor output 2.2 kW and larger: over 20%, Overexcitation Braking/High Slip Braking allow for approximately 40% Continuous regenerative torque: Approximately 20%. Dynamic braking option allows for approximately 125%, 10%ED, 10 s <p>⚠ WARNING Set L3-04 = 0 [Stall Prevention during Decel = Disabled] when you operate the drive with:</p> <ul style="list-style-type: none"> a regenerative converter regenerative unit braking unit braking resistor braking resistor unit. <p><i>If you set the parameter incorrectly, the drive can decelerate for too long and cause serious injury or death.</i></p> <p>Note:</p> <ul style="list-style-type: none"> Models 2004 to 2138 and 4002 to 4168 have a braking transistor. Short-time average deceleration torque refers to the torque needed to decelerate the motor (uncoupled from the load) from the rated speed to zero. Motor characteristics can change the actual specifications. Motor characteristics change the continuous regenerative torque and short-time average deceleration torque for motors 2.2 kW and larger.
V/f Characteristics	Select from 15 pre-defined V/f patterns, or a user-set V/f pattern.
Main Control Functions	Torque Control, Droop Control, Speed/Torque Control Switching, Feed Forward Control, Zero Servo Function, Restart After Momentary Power Loss, Speed Search, Overtorque/Undertorque Detection, Torque Limit, 17 Step Speed (max.), Accel/Decel Switch, S-curve Acceleration/Deceleration, 3-wire Sequence, Auto-Tuning (Rotational and Stationary), Dwell Function, Cooling Fan ON/OFF Switch, Slip Compensation, Torque Compensation, Frequency Jump, Upper/Lower Limits for Frequency Reference, DC Injection Braking at Start and Stop, Overexcitation Braking, High Slip Braking, PID Control (with Sleep Function), Energy Saving Control, MEMOBUS/Modbus Communication (RS-485 max, 115.2 kbps), Auto Restart, Application Presets, DriveWorksEZ (customized functions), Removable Terminal Block, Online Tuning, KEB, Overexcitation Deceleration, Inertia (ASR) Tuning, Overvoltage Suppression, High Frequency Injection

Table 5.2 Protection Functions

Item	Specification
Motor Protection	Electronic thermal overload protection
Momentary Overcurrent Protection	Drive stops when the output current is more than 200% of the HD output current.
Overload Protection	<p>Drive stops when the output current is more than these overload tolerances:</p> <ul style="list-style-type: none"> HD: 150% of the rated output current for 60 seconds The permitted frequency of overload is one time each 10 minutes. ND: 110% of the rated output current for 60 seconds The permitted frequency of overload is one time each 10 minutes. <p>Note:</p> <p>If output frequency < 6 Hz, the drive can trigger the overload protection function when the output current is in the overload tolerance range.</p>
Overvoltage Protection	<p>200 V class: Stops when the DC bus voltage is more than approximately 410 V</p> <p>400 V class: Stops when the DC bus voltage is more than approximately 820 V</p>
Undervoltage Protection	<p>200 V class: Stops when the DC bus voltage decreases to less than approximately 190 V</p> <p>400 V class: Stops when the DC bus voltage decreases to less than approximately 380 V</p>
Momentary Power Loss Ride-thru	<p>Stops when power loss is longer than 15 ms.</p> <p>Continues operation if power loss is shorter than 2 s (depending on parameter settings).</p> <p>Note:</p> <ul style="list-style-type: none"> Stop time may be shortened depending on the load and motor speed. Drive capacity will change the continuous operation time. A Momentary Power Loss Recovery Unit is necessary to continue operation through a 2 s power loss on models 2004 to 2056 and 4002 to 4031.
Heatsink Overheat Protection	Thermistor
Braking Resistor Overheat Protection	Overheat detection for braking resistor (optional ERF-type, 3% ED)
Stall Prevention	Stall prevention is available during acceleration, deceleration, and during run.
Ground Fault Protection	<p>Electronic circuit protection</p> <p>Note:</p> <p>This protection detects ground faults during run. The drive will not provide protection when:</p> <ul style="list-style-type: none"> There is a low-resistance ground fault for the motor cable or terminal block Energizing the drive when there is a ground fault.
DC Bus Charge LED	Charge LED illuminates when DC bus voltage is more than 50 V.

Table 5.3 Environment

Item	Specification
Area of Use	Indoors
Power Supply	Overvoltage Category III
Ambient Temperature Setting	Open chassis type (IP20): -10°C to +50 °C (14 °F to 122 °F) Enclosed wall-mounted type (UL Type 1): -10 °C to +40 °C (14 °F to 104 °F) <ul style="list-style-type: none"> • Drive reliability is better in environments that do not have wide temperature fluctuations. • When installing the drive in an enclosure, use a cooling fan or air conditioner to keep the internal air temperature in the permitted range. • Do not let the drive freeze. • You can use open-chassis type (IP20) drives at a maximum of 60 °C (140 °F) when you derate the output current. • You can use enclosed wall-mounted type (UL Type 1) drives at a maximum of 50 °C (122 °F) when you derate the output current.
Humidity	95% RH or less Do not let condensation form on the drive.
Storage Temperature	-20 °C to +70 °C (-4 °F to +158 °F) (short-term temperature during transportation)
Surrounding Area	Pollution degree 2 or less Install the drive in an area without: <ul style="list-style-type: none"> • Oil mist, corrosive or flammable gas, or dust • Metal powder, oil, water, or other unwanted materials • Radioactive materials or flammable materials, including wood • Harmful gas or fluids • Salt • Direct sunlight
Altitude	1000 m (3281 ft) maximum Note: Derate the output current by 1% for each 100 m (328 ft) to install the drive in altitudes between 1000 m to 4000 m (3281 ft to 13123 ft). It is not necessary to derate the rated voltage in these conditions: <ul style="list-style-type: none"> • Installing the drive at 2000 m (6562 ft) or lower • Installing the drive between 2000 m to 4000 m (6562 ft to 13123 ft) and grounding the neutral point on the power supply. Contact Yaskawa or your nearest sales representative when not grounding the neutral point.
Vibration	<ul style="list-style-type: none"> • 10 Hz to 20 Hz: 1 G (9.8 m/s², 32.15 ft/s²) • 20 Hz to 55 Hz: 2004 to 2211, 4002 to 4168: 0.6 G (5.9 m/s², 19.36 ft/s²) 2257 to 2415, 4208 to 4720: 0.2 G (2.0 m/s², 6.56 ft/s²)
Installation Orientation	Install the drive vertically for sufficient airflow to cool the drive.

Table 5.4 Standard

Item	Specification
Standard	<ul style="list-style-type: none"> • UL508C • EN61800-3 • IEC/EN61800-5-1 • Two Safe Disable inputs and one EDM output according to EN ISO 13849-1:2015 (PL e (Cat.III)), IEC/EN61508 SIL3
Protection Design	Open-chassis type (IP20) Enclosed wall-mounted type (UL Type 1) Note: Install a UL Type 1 kit on an open-chassis type (IP20) drive to convert the drive to a wall-mount enclosure (UL Type 1).

◆ Area of Use

Install this product in a location with Overvoltage Category III and pollution degree 2 or less as specified in UL508C.

■ Ambient Temperature Setting

Maintain the ambient temperature within the following ranges according to the enclosure type.

- Enclosed wall-mounted type (UL Type 1): -10 °C to +40 °C (14 °F to 104 °F)
- Open chassis type (IP20): -10 °C to +50 °C (14 °F to 122 °F)

6 Mechanical Installation

This section gives directions about the standard environment for correct installation.

◆ Moving the Drive

Obey local laws and regulations when moving and installing this product.

⚠ CAUTION *Crush Hazard. Tighten terminal cover screws and hold the case safely when you move the drive. If the drive or covers fall, it can cause moderate injury.*

Drive Weight	Persons Necessary to Move the Drive
< 15 kg (33 lb)	1
≥ 15 kg (33 lb)	2 + using appropriate lifting equipment

Refer to the Technical Manual for information about moving the drive with suspension systems, wires, or hanging metal brackets.

◆ Using the Hanging Brackets to Move the Drive

Use the hanging brackets attached to the drive to temporarily lift the drive when you install the drive to a control panel or wall or when you replace the drive. Do not let the drive stay vertically or horizontally suspended or move the drive over a long distance while it is suspended.

Before you install the drive, make sure that you read these precautions:

⚠ WARNING *Crush Hazard. Before you hang the drive vertically, use screws to correctly attach the drive front cover and other drive components. If you do not secure the front cover, it can fall and cause minor injury.*

⚠ WARNING *Crush Hazard. When you use a crane or hoist to lift the drive during installation or removal, prevent more than 1.96 m/s² (0.2 G) vibration or impact. Too much vibration or impact can cause serious injury or death from falling equipment.*

⚠ WARNING *Crush Hazard. When you lift the drive during installation or removal, do not try to turn the drive over and do not ignore the hanging drive. If you move a hanging drive too much or if you ignore it, the drive can fall and cause serious injury or death.*

◆ Installation Position and Distance

Install the drive vertically for sufficient airflow to cool the drive.

Note:

Contact Yaskawa or a Yaskawa representative for more information about installing drive models on their side.

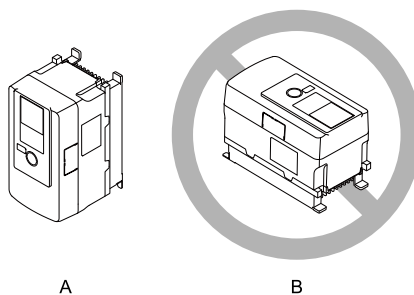

A - Vertical installation

B - Horizontal installation

Figure 6.1 Installation Position

■ Single Drive Installation

Use the clearances specified in [Figure 6.2](#) to install the drive. Make sure that there is sufficient space for wiring and airflow.

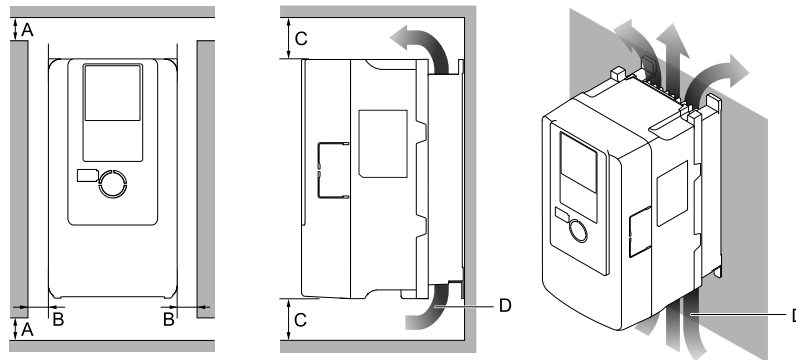

- A - 50 mm (2 in) minimum
- B - 30 mm (1.2 in) minimum on both sides
- C - 120 mm (4.7 in) minimum above and below
- D - Airflow direction

Figure 6.2 Installation Distances for One Drive

■ Install Drives Side-by-Side

Users can install drive models 2004xB to 2082xB and 4002xB to 4044xB side-by-side.

To install other drive models adjacent to each other, you must keep 30 mm (1.2 in) between each drive.

For side-by-side installation of drive models 2004xB to 2082xB and 4002xB to 4044xB, make sure that there is sufficient space as shown in Figure 6.3. Set L8-35 = 1 [Installation Method Selection = Side-by-Side Mounting].

Derate the output current to align with the ambient temperature.

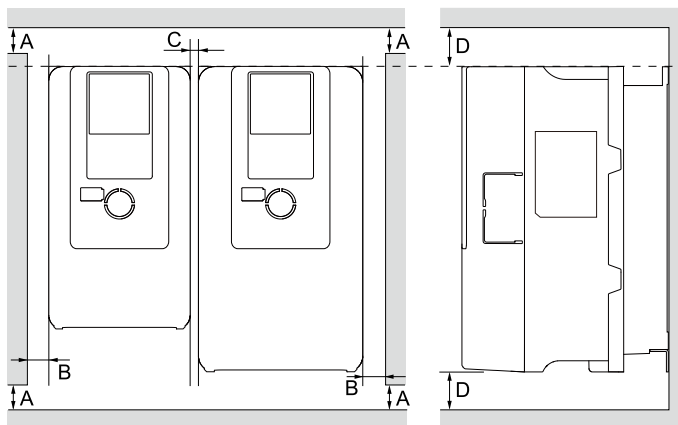

- A - 50 mm (2 in) minimum
- B - 30 mm (1.2 in) minimum on both sides
- C - 2 mm (0.08 in) minimum between each drive
- D - 120 mm (4.7 in) minimum above and below

Figure 6.3 Installation Distances for Multiple Drives (Side-by-Side)

Note:

- Align the tops of drives that have different dimensions to help when you replace cooling fans.
- Remove the top protective covers of all drives when mounting UL Type 1 enclosure drives side-by-side.

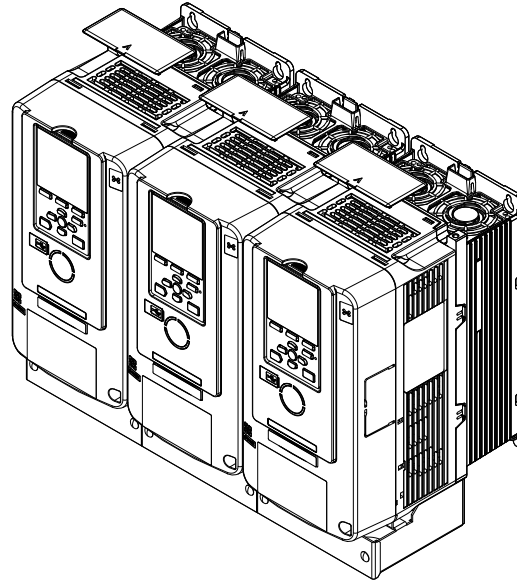

Figure 6.4 Enclosed Wall-Mounted Type (UL Type 1) Installed Side-by-Side

◆ Removing/Reattaching Covers

This section gives information about how to remove and reattach the front cover and terminal cover for wiring and inspection.

Different drive models have different procedures to remove and reattach the covers. Refer to [Table 6.1](#) for more information.

Table 6.1 Procedures to Remove Covers by Drive Model

Model	Procedure	Reference
2004 - 2211 4002 - 4168	Procedure A	17
2257 - 2415 4208 - 4720	Procedure B	19

■ Removing/Reattaching the Cover Using Procedure A

⚠ DANGER *Electrical Shock Hazard. Do not examine, connect, or disconnect wiring on an energized drive. Before servicing, disconnect all power to the equipment and wait for the time specified on the warning label at a minimum. The internal capacitor stays charged after the drive is de-energized. The charge indicator LED extinguishes when the DC bus voltage decreases below 50 Vdc. When all indicators are OFF, remove the covers before measuring for dangerous voltages to make sure that the drive is safe. If you do work on the drive when it is energized, it will cause serious injury or death from electrical shock. The drive has internal capacitors that stay charged after you de-energize the drive.*

Remove the Front Cover

1. Remove the keypad and the keypad connector, then insert the end of the keypad connector that has the tab into the keypad connector holder on the front cover.

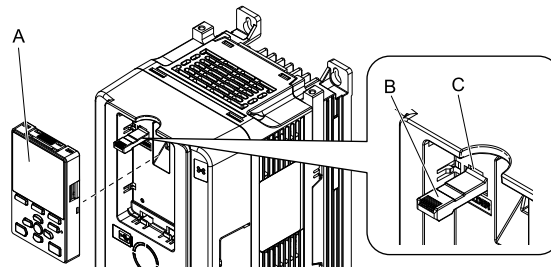

A - Keypad

B - Keypad connector

C - Holder

Figure 6.5 Remove the Keypad and Keypad Connector

2. Loosen the front cover screws.

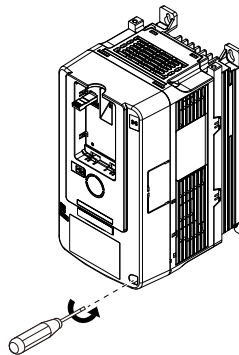

Figure 6.6 Loosen the Front Cover Screws

3. Push on the tab in the side of the front cover then pull the front cover forward to remove it from the drive.

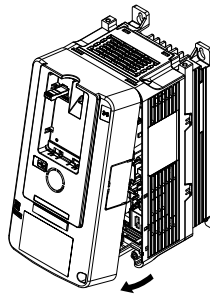

Figure 6.7 Remove the Front Cover

Reattach the Front Cover

1. Wire the drive and other peripheral devices.
2. Reverse the steps to reattach the cover.

Note:

- Wire the grounding terminals first, main circuit terminals next, and control circuit terminals last.
- Make sure that you do not pinch wires or signal lines between the front cover and the drive before you reattach the cover.
- Tighten the screws to a tightening torque of 0.98 N·m to 1.33 N·m (8.67 in·lb to 11.77 in·lb).

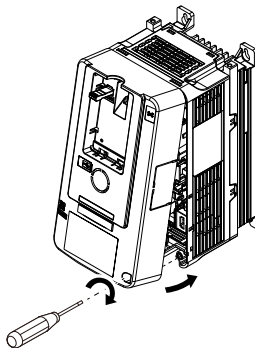

Figure 6.8 Reattach the Front Cover

3. Reattach the keypad to the original position.

■ Removing/Reattaching the Cover Using Procedure B

⚠ DANGER *Electrical Shock Hazard. Do not examine, connect, or disconnect wiring on an energized drive. Before servicing, disconnect all power to the equipment and wait for the time specified on the warning label at a minimum. The internal capacitor stays charged after the drive is de-energized. The charge indicator LED extinguishes when the DC bus voltage decreases below 50 Vdc. When all indicators are OFF, remove the covers before measuring for dangerous voltages to make sure that the drive is safe. If you do work on the drive when it is energized, it will cause serious injury or death from electrical shock. The drive has internal capacitors that stay charged after you de-energize the drive.*

Remove the Front Cover

1. Remove the terminal cover, keypad, and keypad connector, then insert the end of the keypad connector that has the tab into the keypad connector holder on the front cover.

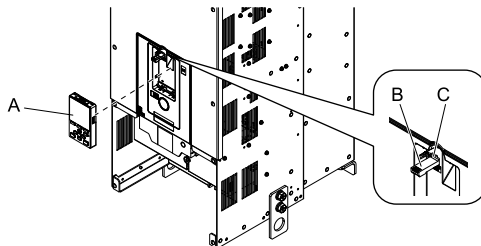

A - Keypad
B - Keypad connector

C - Connector holder

Figure 6.9 Remove the Terminal Cover, Keypad, and Keypad Connector

2. Loosen the front cover screws.

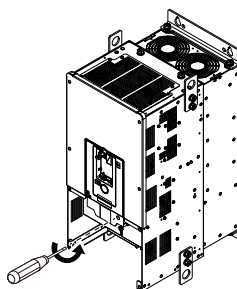
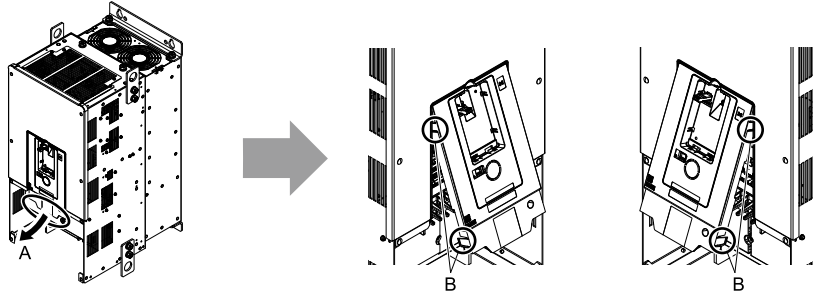

Figure 6.10 Loosen the Front Cover Screws

3. Push on the four tabs found on each side of the front cover, then pull the front cover forward to remove it from the drive.



A - Pull forward to remove the front cover.

B - Unhook the tabs found on the sides of the front cover.

Figure 6.11 Pull Forward to Remove the Front Cover

4. Remove the front cover from the drive.

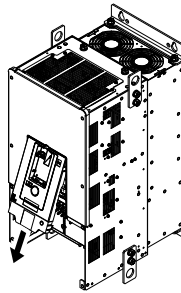

Figure 6.12 Remove the Front Cover

Reattach the Front Cover

Wire the drive and other peripheral devices then reattach the front cover.

Note:

Wire the grounding terminals first, main circuit terminals next, and control circuit terminals last.

1. Move the front cover to connect the hooks at the top of the front cover to the drive.

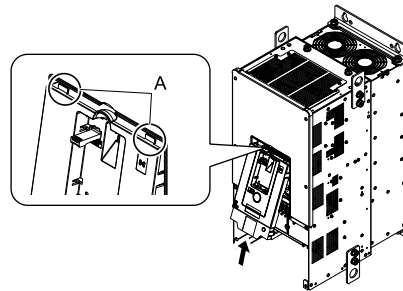

A - Hooks

Figure 6.13 Reattach the Front Cover

2. Move the front cover until it clicks into position while pushing on the hooks on the left and right sides of the front cover.

Note:

Make sure that you do not pinch wires or signal lines between the front cover and the drive before you reattach the cover.

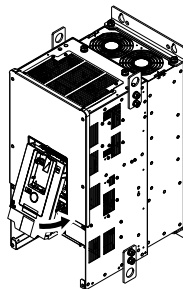

Figure 6.14 Reattach the Front Cover

3. Reattach the keypad to the original position.

Remove the Terminal Cover

1. Loosen the screws on the terminal cover, then pull down on the cover.

CAUTION *Crush Hazard. Loosen the cover screws. Do not fully remove them. If you fully remove the cover screws, the terminal cover can fall and cause moderate injury.*

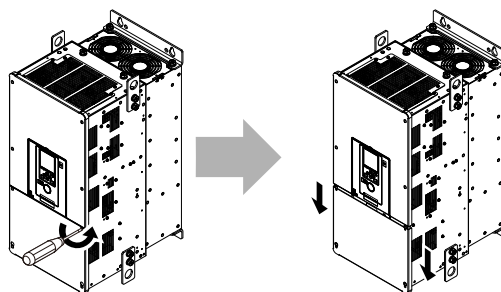

Figure 6.15 Loosen the Terminal Cover Mounting Screws

2. Pull the terminal cover away from the drive.

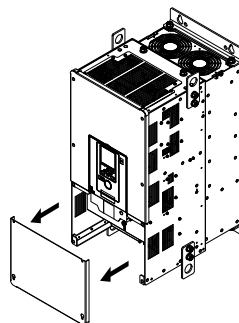

Figure 6.16 Remove the Terminal Cover

Reattach the Terminal Cover

Wire the drive and other peripheral devices then reattach the terminal cover.

Note:

- Wire the grounding terminals first, main circuit terminals next, and control circuit terminals last.
- Make sure that you do not pinch wires or signal lines between the wiring cover and the drive before you reattach the cover.
- Tighten the screws to a tightening torque of 0.98 N·m to 1.33 N·m (8.67 in·lb to 11.77 in·lb).

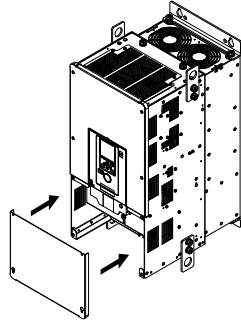

Figure 6.17 Reattach the Terminal Cover

7 Electrical Installation

⚠ DANGER *Electrical Shock Hazard. Do not examine, connect, or disconnect wiring on an energized drive. Before servicing, disconnect all power to the equipment and wait for the time specified on the warning label at a minimum. The internal capacitor stays charged after the drive is de-energized. The charge indicator LED extinguishes when the DC bus voltage decreases below 50 Vdc. When all indicators are OFF, remove the covers before measuring for dangerous voltages to make sure that the drive is safe. If you do work on the drive when it is energized, it will cause serious injury or death from electrical shock. The drive has internal capacitors that stay charged after you de-energize the drive.*

⚠ WARNING *Electrical Shock Hazard. Make sure that all electrical connections are correct and install all drive covers before you energize the drive. Use terminals for their correct function only. Incorrect wiring connections and incorrect cover installation can cause serious injury or death.*

⚠ WARNING *Electrical Shock Hazard. Use the terminals for the drive only for their intended purpose. Refer to the technical manual for more information about the I/O terminals. Wiring and grounding incorrectly or modifying the cover may damage the equipment or cause injury.*

◆ Standard Connection Diagram

Wire the drive as specified by [Figure 7.1](#).

⚠ WARNING *Sudden Movement Hazard. Set the MFDI parameters before you close control circuit switches. Incorrect Run/Stop circuit sequence settings can cause serious injury or death from moving equipment.*

⚠ WARNING *Sudden Movement Hazard. Correctly wire the start/stop and safety circuits before you energize the drive. If you momentarily close a digital input terminal, it can start a drive that is programmed for 3-Wire control and cause serious injury or death from moving equipment.*

⚠ WARNING *Sudden Movement Hazard. When you use a 3-Wire sequence, set A1-03 = 3330 [Initialize Parameters = 3-Wire Initialization] and make sure that b1-17 = 0 [Run Command at Power Up = Disregard Existing RUN Command] (default). If you do not correctly set the drive parameters for 3-Wire operation before you energize the drive, the motor can suddenly rotate in reverse when you energize the drive.*

⚠ WARNING *Sudden Movement Hazard. Check the I/O signals and the external sequences for the drive before you set the Application Preset function. When you set the Application Preset function (A1-06 ≠ 0), it changes the I/O terminal functions for the drive and it can cause equipment to operate unusually. This can cause serious injury or death.*

NOTICE *Fire Hazard. Install sufficient branch circuit short circuit protection as specified by applicable codes and this manual. The drive is suited for circuits that supply not more than 100,000 RMS symmetrical amperes, 240 Vac maximum (200 V Class), 480 Vac maximum (400 V Class). Incorrect branch circuit short circuit protection can cause serious injury or death.*

NOTICE *When the input voltage is 440 V or higher or the wiring distance is longer than 100 m (328 ft), make sure that the motor insulation voltage is sufficient or use an inverter-duty motor or vector-duty motor with reinforced insulation. Motor winding and insulation failure can occur.*

NOTICE *Do not connect the AC control circuit ground to the drive enclosure. Incorrect ground wiring can cause the control circuit to operate incorrectly.*

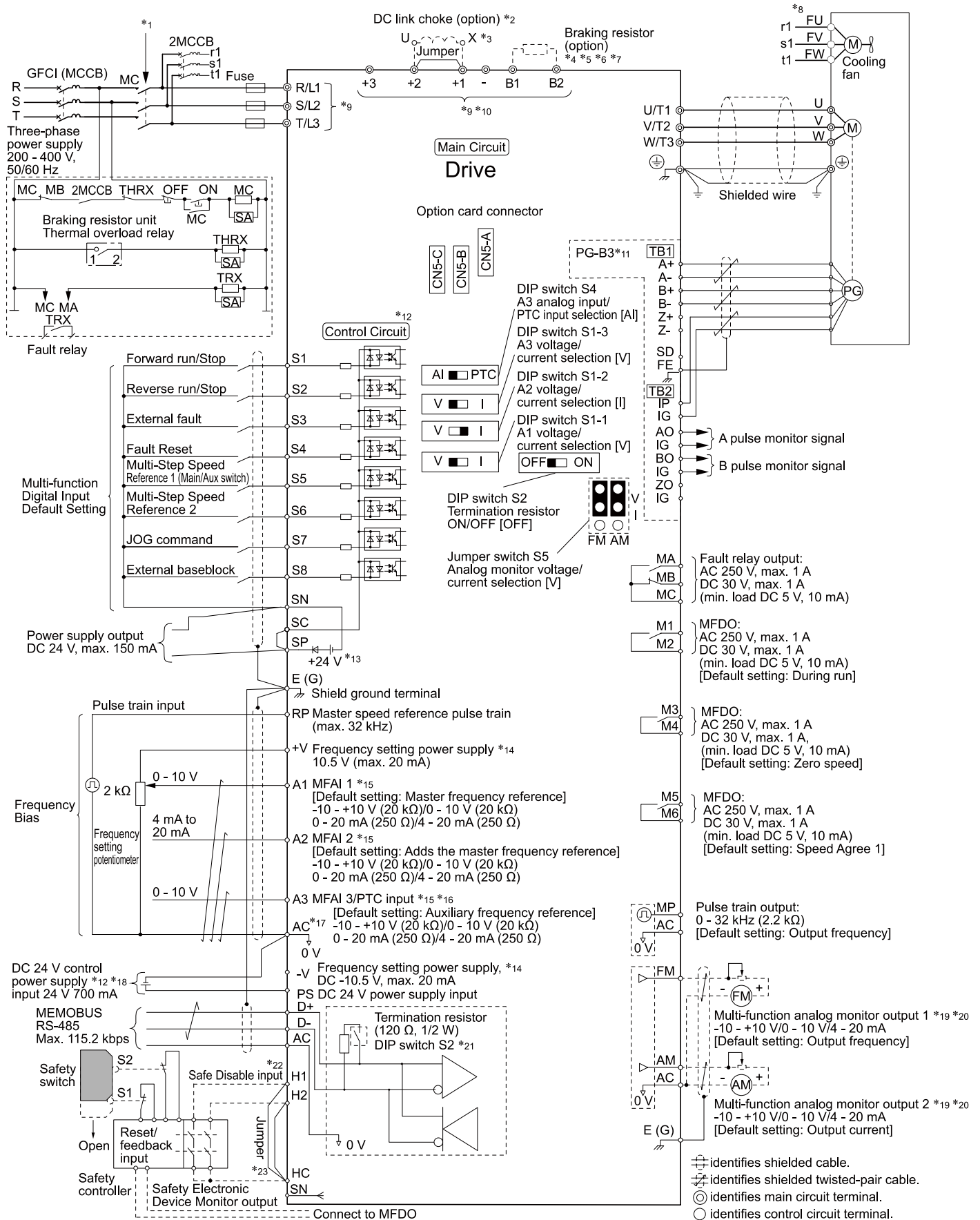

Figure 7.1 Standard Drive Connection Diagram

- *1 Set the wiring sequence to de-energize the drive with the fault relay output. If the drive outputs a fault during fault restart when you use the fault restart function, set $L5-02 = 1$ [*Fault Contact at Restart Select = Always Active*] to de-energize the drive. Be careful when you use a cut-off sequence. The default setting for $L5-02$ is 0 [*Active Only when Not Restarting*].
- *2 When you install a DC link choke, you must remove the jumper between terminals +1 and +2.
- *3 Models 2110 to 2415 and 4060 to 4720 have a DC link choke.
- *4 When you use a regenerative converter, regenerative unit, or braking unit, set $L8-55 = 0$ [*Internal DB Transistor Protection = Disable*]. If $L8-55 = 1$ [*Protection Enabled*], the drive will detect rF [*Braking Resistor Fault*].
- *5 When you use a regenerative converter, regenerative unit, braking unit, braking resistor, or braking resistor unit, set $L3-04 = 0$ [*Stall Prevention during Decel = Disabled*]. If $L3-04 = 1$ [*General Purpose*], the drive could possibly not stop in the specified deceleration time.
- *6 When you use an ERF-type braking resistor, set $L8-01 = 1$ [*3% ERF DB Resistor Protection = Enabled*] and set a wiring sequence to de-energize the drive with the fault relay output.
- *7 When you connect a braking unit (CDBR series) or a braking resistor unit (LKEB series) to drive models 2110, 2138, and 4103, make sure that you use wires that are in the range of the applicable gauges for the drive. A junction terminal is necessary to connect wires that are less than the applicable gauge to the drive. Contact Yaskawa or your nearest sales representative for more information about selection and installation of the junction terminal.
- *8 Cooling fan wiring is not necessary for self-cooling motors.
- *9 Connect peripheral options to terminals -, +1, +2, B1, and B2.

⚠ WARNING *Fire Hazard. Only connect factory-recommended devices or circuits to drive terminals B1, B2, -, +1, +2, and +3 terminals. Do not connect AC power to these terminals. Incorrect wiring can cause damage to the drive and serious injury or death from fire.*

- *10 Encoder circuit wiring (wiring to PG-B3 option card) is not necessary for applications that do not use motor speed feedback.
- *11 Connect a 24 V power supply to terminals PS-AC to operate the control circuit while the main circuit power supply is OFF.
- *12 Install the wire jumpers between terminals SC-SP and SC-SN to set the MFDI power supply (sinking/sourcing mode or internal/external power supply).

NOTICE *Do not close the circuit between terminals SP and SN. A closed circuit between these terminals will cause damage to the drive.*

- Sinking Mode: Install a jumper between terminals SC and SP.

NOTICE *Do not close the circuit between terminals SC and SN. A closed circuit between these terminals will cause damage to the drive.*

- Sourcing Mode: Install a jumper between terminals SC and SN.

NOTICE *Do not close the circuit between terminals SC and SP. A closed circuit between these terminals will cause damage to the drive.*

- External power supply: No jumper necessary between terminals SC-SN and terminals SC-SP.

- *13 The maximum output current capacity for terminals +V and -V on the control circuit is 20 mA.

NOTICE *Do not install a jumper between terminals +V, -V, and AC. A closed circuit between these terminals will cause damage to the drive.*

- *14 DIP switches S1-1 to S1-3 set terminals A1 to A3 for voltage or current input. The default setting for S1-1 and S1-3 is voltage input ("V" side). The default setting for S1-2 is current input ("I" side).
- *15 DIP switch S4 sets terminal A3 for analog or PTC input. Set DIP switch S1-3 to the "V" side, and set $H3-05 = 0$ [*Terminal A3 Signal Level Select = 0 to 10V (Lower Limit at 0)*] to set terminal A3 for PTC input with DIP switch S4.
- *16 Do not ground the control circuit terminals AC or connect them to the drive.

⚠ WARNING *Do not ground the AC control circuit terminals and only connect the AC terminals according to the product instructions. If you connect the AC terminals incorrectly, it can cause damage to the drive.*

- *17 Connect the positive lead from an external 24 Vdc power supply to terminal PS and the negative lead to terminal AC.

NOTICE Connect terminals PS and AC correctly for the 24 V power supply. If you connect the wires to the incorrect terminals, it will cause damage to the drive.

- *18 Use multi-function analog monitor outputs with analog frequency meters, ammeters, voltmeters, and wattmeters. Do not use monitor outputs with feedback-type signal devices.
- *19 Jumper switch S5 sets terminal FM and AM for voltage or current output. The default setting for S5 is voltage output (“V” side).
- *20 Set DIP switch S2 to “ON” to enable the termination resistor in the last drive in a MEMOBUS/Modbus network.
- *21 Use only SOURCE Mode for Safe Disable input.
- *22 Disconnect the jumpers between H1 and HC and H2 and HC to use the Safe Disable input.

◆ Main Circuit Terminal Functions

Refer to [Table 7.1](#) for the functions of drive main circuit terminals.

Table 7.1 Main Circuit Terminal Functions

Terminals	Name				Function
	2004 - 2082	2110 - 2138	2169 - 2415	-	
Model	4002 - 4044	4060 - 4168	4208 - 4414	4477 - 4720	
R/L1	Main circuit power supply input				To connect a commercial power supply.
S/L2					
T/L3					
U/T1	Drive output				To connect a motor.
V/T2					
W/T3					
B1	Braking resistor connection		-		To connect a braking resistor or braking resistor unit.
B2					
+2	<ul style="list-style-type: none"> • DC power supply input (+1 and -) • DC reactor connection (+1 and +2) 	DC power supply input (+1 and -)	-		To connect peripheral devices, for example: <ul style="list-style-type: none"> • DC power input • Braking unit • DC link choke Note: Remove the jumper between terminals +1 and +2 to connect a DC link choke.
+1					
-					
+3	-		<ul style="list-style-type: none"> • DC power supply input (+1 and -) • Braking unit connection (+3 and -) 		
	<ul style="list-style-type: none"> • 200 V: D class grounding (ground to 100 Ω or less) • 400 V: C class grounding (ground to 10 Ω or less) 				To ground the drive.

Note:

Use terminals B1 and - to connect a CDBR-type control unit to drive models 2004 to 2138 and 4002 to 4168 that have built-in braking transistors.

◆ Motor and Main Circuit Connections

⚠ WARNING Electrical Shock Hazard. Do not connect terminals R/L1, S/L2, T/L3, U/T1, V/T2, W/T3, -, +1, +2, +3, B1, or B2 to the ground terminal. If you connect these terminals to earth ground, it can cause damage to the drive or serious injury or death.

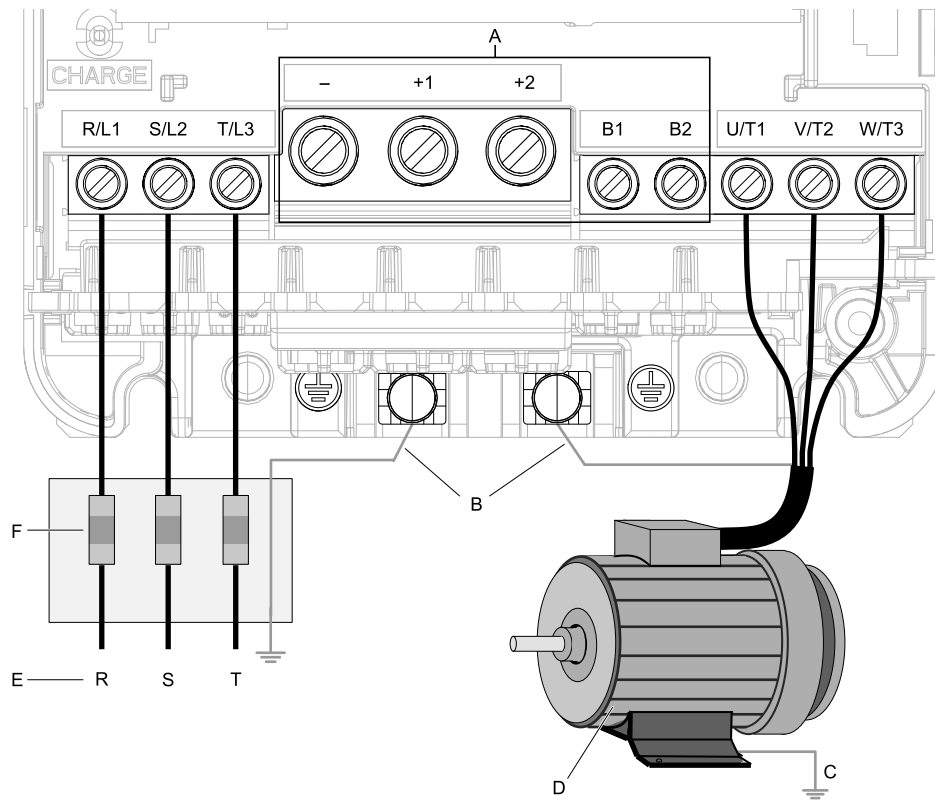

- A - DC bus terminal
- B - Connect to the drive ground terminal.
- C - Ground the motor case.
- D - Three-Phase Motor
- E - Use R, S, T for input power supply.
- F - Input Protection (Fuses or Circuit Breakers)

Note:

The location of terminals are different for different drive models.

Figure 7.2 Wiring the Main Circuit and Motor

◆ Main Circuit Terminal Block Wiring

■ Wire Selection

Use this section to select the correct wires for main circuit wiring.

Wire Selection Precautions

⚠ WARNING *Electrical Shock Hazard. Make sure that the protective ground wire conforms to technical standards and local safety regulations. The IEC/EN 61800-5-1:2007 standard specifies that you must wire the power supply to automatically de-energize when the protective ground wire disconnects. You can also connect a protective ground wire that has a minimum cross-sectional area of 10 mm² (copper wire) or 16 mm² (aluminum wire). If you do not obey the standards and regulations, it can cause serious injury or death. The leakage current of the drive will be more than 3.5 mA in drive models 4414 to 4720.*

Think about line voltage drop before selecting wire gauges. Select wire gauges that drop the voltage by 2% or less of the rated voltage. Increase the wire gauge and the cable length when the risk of voltage drops increases. Calculate line voltage drop with this formula:

$$\text{Line voltage drop (V)} = \sqrt{3} \times \text{wire resistance } (\Omega/\text{km}) \times \text{wiring distance (m)} \times \text{motor rated current (A)} \times 10^{-3}$$

Precautions during Wiring

- Use terminals B1 and - to connect braking units to drives that have built-in braking transistors (models 2004 to 2138 and 4002 to 4168). Use terminals +3 and - to connect braking units to drives that do not have built-in braking transistors.
- Refer to “Yaskawa AC Drive Option Braking Unit, Braking Resistor Unit Instruction Manual (TOBPC72060001)” for information about wire gauges and tightening torques to connect braking resistor units or braking units.
- Use terminals +1 and - to connect a regenerative converter or regenerative unit.

⚠ WARNING *Fire Hazard. Do not connect a braking resistor to terminals +1 or -. Use terminals B1 and B2 for the braking resistor connections. If you connect a braking resistor to the incorrect terminals, it can cause damage to the drive and braking circuit and serious injury or death.*

Wire Gauge and Torque Specifications for UL Listing

Refer to *Three-Phase 200 V Class on page 27* and *Three-Phase 400 V Class on page 31* for the recommended wire gauges and tightening torques of the main circuit terminals.

Note:

- The recommended wire gauges are based on drive continuous current ratings with 75 °C (167 °F) 600 V class 2 heat-resistant indoor PVC wire. Assume these conditions:
 - Ambient temperature: 40 °C (104 °F) or lower
 - Wiring distance: 100 m (328 ft) or shorter
 - Normal Duty Rated current value
- Use terminals +1, +2, +3, -, B1, and B2 to connect a peripheral option such as a DC link choke or a braking resistor. Do not connect other items to these terminals.
- Refer to the instruction manual for each device for recommended wire gauges to connect peripheral devices or options to terminals +1, +2, +3, -, B1, and B2. Contact Yaskawa or your nearest sales representative if the recommended wire gauges for the peripheral devices or options are out of the range of the applicable gauges for the drive.

Three-Phase 200 V Class

Model	Terminals	Recommended Gauge AWG, kcmil	Applicable Gauge (IP20 Applicable Gauge ^{*1}) AWG, kcmil	Wire Stripping Length ^{*2} mm	Terminal Screw		Tightening Torque N·m (in·lb)
					Size	Shape	
2004	R/L1, S/L2, T/L3	14	14 - 6 (14 - 6)	10	M4	Slotted (-)	1.5 - 1.7 (13.5 - 15)
	U/T1, V/T2, W/T3	14	14 - 6 (14 - 6)	10	M4	Slotted (-)	1.5 - 1.7 (13.5 - 15)
	-, +1, +2	14	14 - 3 (14 - 3)	18	M5	Slotted (-)	2.3 - 2.5 (19.8 - 22) ^{*3}
	B1, B2	14	14 - 10 (14 - 10)	10	M4	Slotted (-)	1.5 - 1.7 (13.5 - 15)
	⊕	10	14 - 8 (-)	-	M4	Phillips/slotted combo	1.2 - 1.5 (10.6 - 13.3)
2006	R/L1, S/L2, T/L3	14	14 - 6 (14 - 6)	10	M4	Slotted (-)	1.5 - 1.7 (13.5 - 15)
	U/T1, V/T2, W/T3	14	14 - 6 (14 - 6)	10	M4	Slotted (-)	1.5 - 1.7 (13.5 - 15)
	-, +1, +2	14	14 - 3 (14 - 3)	18	M5	Slotted (-)	2.3 - 2.5 (19.8 - 22) ^{*3}
	B1, B2	14	14 - 10 (14 - 10)	10	M4	Slotted (-)	1.5 - 1.7 (13.5 - 15)
	⊕	10	14 - 8 (-)	-	M4	Phillips/slotted combo	1.2 - 1.5 (10.6 - 13.3)
2008	R/L1, S/L2, T/L3	14	14 - 6 (14 - 6)	10	M4	Slotted (-)	1.5 - 1.7 (13.5 - 15)
	U/T1, V/T2, W/T3	14	14 - 6 (14 - 6)	10	M4	Slotted (-)	1.5 - 1.7 (13.5 - 15)
	-, +1, +2	14	14 - 3 (14 - 3)	18	M5	Slotted (-)	2.3 - 2.5 (19.8 - 22) ^{*3}
	B1, B2	14	14 - 10 (14 - 10)	10	M4	Slotted (-)	1.5 - 1.7 (13.5 - 15)
	⊕	10	14 - 8 (-)	-	M4	Phillips/slotted combo	1.2 - 1.5 (10.6 - 13.3)

7 Electrical Installation

Model	Terminals	Recommended Gauge AWG, kcmil	Applicable Gauge (IP20 Applicable Gauge *1) AWG, kcmil	Wire Stripping Length *2 mm	Terminal Screw		Tightening Torque N-m (in-lb)
					Size	Shape	
2010	R/L1, S/L2, T/L3	12	14 - 6 (14 - 6)	10	M4	Slotted (-)	1.5 - 1.7 (13.5 - 15)
	U/T1, V/T2, W/T3	14	14 - 6 (14 - 6)	10	M4	Slotted (-)	1.5 - 1.7 (13.5 - 15)
	-, +1, +2	12	14 - 3 (14 - 3)	18	M5	Slotted (-)	2.3 - 2.5 (19.8 - 22) *3
	B1, B2	14	14 - 10 (14 - 10)	10	M4	Slotted (-)	1.5 - 1.7 (13.5 - 15)
	⊕	10	14 - 8 (-)	-	M4	Phillips/slotted combo	1.2 - 1.5 (10.6 - 13.3)
2012	R/L1, S/L2, T/L3	10	14 - 6 (14 - 6)	10	M4	Slotted (-)	1.5 - 1.7 (13.5 - 15)
	U/T1, V/T2, W/T3	12	14 - 6 (14 - 6)	10	M4	Slotted (-)	1.5 - 1.7 (13.5 - 15)
	-, +1, +2	10	14 - 3 (14 - 3)	18	M5	Slotted (-)	2.3 - 2.5 (19.8 - 22) *3
	B1, B2	14	14 - 10 (14 - 10)	10	M4	Slotted (-)	1.5 - 1.7 (13.5 - 15)
	⊕	10	14 - 8 (-)	-	M4	Phillips/slotted combo	1.2 - 1.5 (10.6 - 13.3)
2018	R/L1, S/L2, T/L3	10	14 - 6 (14 - 6)	10	M4	Slotted (-)	1.5 - 1.7 (13.5 - 15)
	U/T1, V/T2, W/T3	10	14 - 6 (14 - 6)	10	M4	Slotted (-)	1.5 - 1.7 (13.5 - 15)
	-, +1, +2	8	14 - 3 (14 - 3)	18	M5	Slotted (-)	2.3 - 2.5 (19.8 - 22) *3
	B1, B2	14	14 - 10 (14 - 10)	10	M4	Slotted (-)	1.5 - 1.7 (13.5 - 15)
	⊕	10	14 - 8 (-)	-	M4	Phillips/slotted combo	1.2 - 1.5 (10.6 - 13.3)
2021	R/L1, S/L2, T/L3	8	14 - 6 (14 - 6)	10	M4	Slotted (-)	1.5 - 1.7 (13.5 - 15)
	U/T1, V/T2, W/T3	10	14 - 6 (14 - 6)	10	M4	Slotted (-)	1.5 - 1.7 (13.5 - 15)
	-, +1, +2	8	14 - 3 (14 - 3)	18	M5	Slotted (-)	2.3 - 2.5 (19.8 - 22) *3
	B1, B2	14	14 - 10 (14 - 10)	10	M4	Slotted (-)	1.5 - 1.7 (13.5 - 15)
	⊕	10	12 - 8 (-)	-	M4	Phillips/slotted combo	1.2 - 1.5 (10.6 - 13.3)
2030	R/L1, S/L2, T/L3	6	14 - 6 (14 - 6)	10	M4	Slotted (-)	1.5 - 1.7 (13.5 - 15)
	U/T1, V/T2, W/T3	8	14 - 6 (14 - 6)	10	M4	Slotted (-)	1.5 - 1.7 (13.5 - 15)
	-, +1, +2	6	14 - 3 (14 - 3)	18	M5	Slotted (-)	2.3 - 2.5 (19.8 - 22) *3
	B1, B2	12	14 - 10 (14 - 10)	10	M4	Slotted (-)	1.5 - 1.7 (13.5 - 15)
	⊕	8	10 - 8 (-)	-	M5	Phillips/slotted combo	2.0 - 2.5 (17.7 - 22.1)

Model	Terminals	Recommended Gauge AWG, kcmil	Applicable Gauge (IP20 Applicable Gauge ^{*1}) AWG, kcmil	Wire Stripping Length ^{*2} mm	Terminal Screw		Tightening Torque N·m (in·lb)
					Size	Shape	
2042	R/L1, S/L2, T/L3	6	14 - 6 (14 - 6)	10	M4	Slotted (-)	1.5 - 1.7 (13.5 - 15)
	U/T1, V/T2, W/T3	6	14 - 6 (14 - 6)	10	M4	Slotted (-)	1.5 - 1.7 (13.5 - 15)
	-, +1, +2	3	14 - 3 (14 - 3)	18	M5	Slotted (-)	2.3 - 2.5 (19.8 - 22) ^{*3}
	B1, B2	10	14 - 10 (14 - 10)	10	M4	Slotted (-)	1.5 - 1.7 (13.5 - 15)
	⊕	8	10 - 8 (-)	-	M5	Phillips/slotted combo	2.0 - 2.5 (17.7 - 22.1)
2056	R/L1, S/L2, T/L3	3	14 - 3 (8 - 3)	18	M5	Slotted (-)	2.3 - 2.5 (19.8 - 22) ^{*3}
	U/T1, V/T2, W/T3	4	14 - 4 (10 - 4)	18	M5	Slotted (-)	2.3 - 2.5 (19.8 - 22) ^{*3}
	-, +1, +2	1	14 - 1 (8 - 1)	20	M6	Hex socket cap (WAF: 5 mm)	5 - 5.5 (45 - 49)
	B1, B2	8	14 - 8 (14 - 8)	10	M4	Slotted (-)	1.5 - 1.7 (13.5 - 15)
	⊕	6	8 - 6 (-)	-	M6	Phillips/slotted combo	5.4 - 6.0 (47.8 - 53.1)
2070	R/L1, S/L2, T/L3	1	14 - 1 (6 - 1)	20	M6	Hex socket cap (WAF: 5 mm)	5 - 5.5 (45 - 49)
	U/T1, V/T2, W/T3	3	14 - 3 (6 - 3)	20	M6	Hex socket cap (WAF: 5 mm)	5 - 5.5 (45 - 49)
	-, +1, +2	1/0	14 - 1/0 (4 - 1/0)	20	M6	Hex socket cap (WAF: 5 mm)	5 - 5.5 (45 - 49)
	B1, B2	8	14 - 8 (14 - 8)	10	M4	Slotted (-)	1.5 - 1.7 (13.5 - 15)
	⊕	6	6 - 4 (-)	-	M6	Phillips/slotted combo	5.4 - 6.0 (47.8 - 53.1)
2082	R/L1, S/L2, T/L3	1/0	14 - 1/0 (6 - 1/0)	20	M6	Hex socket cap (WAF: 5 mm)	5 - 5.5 (45 - 49)
	U/T1, V/T2, W/T3	2	14 - 2 (6 - 2)	20	M6	Hex socket cap (WAF: 5 mm)	5 - 5.5 (45 - 49)
	-, +1, +2	2/0	14 - 2/0 (4 - 2/0)	20	M6	Hex socket cap (WAF: 5 mm)	5 - 5.5 (45 - 49)
	B1, B2	6	14 - 6 (14 - 6)	10	M4	Slotted (-)	1.5 - 1.7 (13.5 - 15)
	⊕	6	6 - 4 (-)	-	M6	Phillips/slotted combo	5.4 - 6.0 (47.8 - 53.1)
2110	R/L1, S/L2, T/L3	1/0	6 - 1/0 (6 - 1/0)	27	M6	Hex socket cap (WAF: 5 mm)	8 - 9 (71 - 80)
	U/T1, V/T2, W/T3	1/0	6 - 1/0 (6 - 1/0)	27	M6	Hex socket cap (WAF: 5 mm)	8 - 9 (71 - 80)
	-, +1	2/0	2 - 2/0 (2 - 2/0)	27	M8	Hex socket cap (WAF: 6 mm)	10 - 12 (89 - 107)
	B1, B2	4	14 - 4 (10 - 4)	21	M6	Slotted (-)	3 - 3.5 (27 - 31)
	⊕	6	6 - 4 (-)	-	M6	Hex bolt (+)	5.4 - 6.0 (47.8 - 53.1)

7 Electrical Installation

Model	Terminals	Recommended Gauge AWG, kcmil	Applicable Gauge (IP20 Applicable Gauge ^{*1}) AWG, kcmil	Wire Stripping Length ^{*2} mm	Terminal Screw		Tightening Torque N·m (in·lb)
					Size	Shape	
2138	R/L1, S/L2, T/L3	2/0	6 - 2/0 (2 - 2/0)	27	M6	Hex socket cap (WAF: 5 mm)	8 - 9 (71 - 80)
	U/T1, V/T2, W/T3	2/0	6 - 2/0 (2 - 2/0)	27	M6	Hex socket cap (WAF: 5 mm)	8 - 9 (71 - 80)
	-, +1	4/0	2 - 4/0 (2 - 4/0)	27	M8	Hex socket cap (WAF: 6 mm)	10 - 12 (89 - 107)
	B1, B2	3	14 - 3 (10 - 3)	21	M6	Slotted (-)	3 - 3.5 (27 - 31)
	⊕	4	4 (-)	-	M6	Hex bolt (+)	5.4 - 6.0 (47.8 - 53.1)
2169	R/L1, S/L2, T/L3	4/0	2 - 250 (2/0 - 250)	37	M10	Hex socket cap (WAF: 8 mm)	12 - 14 (107 - 124)
	U/T1, V/T2, W/T3	4/0	2 - 300 (3/0 - 300)	37	M10	Hex socket cap (WAF: 8 mm)	12 - 14 (107 - 124)
	-, -, +1, +1 ^{*4 *5}	1	6 - 2/0 (1/0 - 2/0)	28	M6	Hex socket cap (WAF: 5 mm)	8 - 9 (71 - 80)
	+3 ^{*5}	1/0	4 - 2/0 (1 - 2/0)	28	M8	Hex socket cap (WAF: 6 mm)	8 - 9 (71 - 80)
	⊕	4	4 - 1/0 (-)	-	M8	Hex bolt (slotted)	9.0 - 11 (79.7 - 97.4)
2211	R/L1, S/L2, T/L3	250	2 - 250 (2/0 - 250)	37	M10	Hex socket cap (WAF: 8 mm)	12 - 14 (107 - 124)
	U/T1, V/T2, W/T3	300	2 - 300 (3/0 - 300)	37	M10	Hex socket cap (WAF: 8 mm)	12 - 14 (107 - 124)
	-, -, +1, +1 ^{*4 *5}	2/0	6 - 2/0 (1/0 - 2/0)	28	M6	Hex socket cap (WAF: 5 mm)	8 - 9 (71 - 80)
	+3 ^{*5}	2/0	4 - 2/0 (1 - 2/0)	28	M8	Hex socket cap (WAF: 6 mm)	8 - 9 (71 - 80)
	⊕	4	4 - 1/0 (-)	-	M8	Hex bolt (slotted)	9.0 - 11 (79.7 - 97.4)
2257	R/L1, S/L2, T/L3	2/0 × 2P	3 - 4/0 × 2P (2/0 - 4/0 × 2P)	-	M10	Hex self-locking nut	20 (177)
	U/T1, V/T2, W/T3	2/0 × 2P	3 - 4/0 × 2P (2/0 - 4/0 × 2P)	-	M10	Hex self-locking nut	20 (177)
	-, +1	4/0 × 2P	2 - 250 × 2P (4/0 - 250 × 2P)	-	M10	Hex self-locking nut	20 (177)
	+3	1/0 × 2P	4 - 1/0 × 2P (1/0 × 2P)	-	M10	Hex self-locking nut	20 (177)
	⊕	3	3 - 350 (-)	-	M10	Hex bolt (slotted)	18 - 23 (159 - 204)
2313	R/L1, S/L2, T/L3	4/0 × 2P	3 - 4/0 × 2P (2/0 - 4/0 × 2P)	-	M10	Hex self-locking nut	20 (177)
	U/T1, V/T2, W/T3	3/0 × 2P	3 - 4/0 × 2P (2/0 - 4/0 × 2P)	-	M10	Hex self-locking nut	20 (177)
	-, +1	250 × 2P	2 - 250 × 2P (4/0 - 250 × 2P)	-	M10	Hex self-locking nut	20 (177)
	+3	1/0 × 2P	4 - 1/0 × 2P (1/0 × 2P)	-	M10	Hex self-locking nut	20 (177)
	⊕	2	2 - 350 (-)	-	M10	Hex bolt (slotted)	18 - 23 (159 - 204)

Model	Terminals	Recommended Gauge AWG, kcmil	Applicable Gauge (IP20 Applicable Gauge ^{*1}) AWG, kcmil	Wire Stripping Length ^{*2} mm	Terminal Screw		Tightening Torque N·m (in·lb)
					Size	Shape	
2360	R/L1, S/L2, T/L3	250 × 2P	2/0 - 300 × 2P (250 - 300 × 2P)	-	M12	Hex self-locking nut	35 (310)
	U/T1, V/T2, W/T3	250 × 2P	2/0 - 300 × 2P (250 - 300 × 2P)	-	M12	Hex self-locking nut	35 (310)
	-, +1	350 × 2P	4/0 - 400 × 2P (300 - 400 × 2P)	-	M12	Hex self-locking nut	35 (310)
	+3	3/0 × 2P	1/0 - 4/0 × 2P (-)	-	M12	Hex self-locking nut	35 (310)
	⊕	1	1 - 350 (-)	-	M12	Hex bolt (slotted)	32 - 40 (283 - 354)
2415	R/L1, S/L2, T/L3	250 × 2P	2/0 - 300 × 2P (250 - 300 × 2P)	-	M12	Hex self-locking nut	35 (310)
	U/T1, V/T2, W/T3	300 × 2P	2/0 - 300 × 2P (250 - 300 × 2P)	-	M12	Hex self-locking nut	35 (310)
	-, +1	350 × 2P	4/0 - 400 × 2P (300 - 400 × 2P)	-	M12	Hex self-locking nut	35 (310)
	+3	3/0 × 2P	1/0 - 4/0 × 2P (-)	-	M12	Hex self-locking nut	35 (310)
	⊕	1	1 - 350 (-)	-	M12	Hex bolt (slotted)	32 - 40 (283 - 354)

*1 For IP20 protection, use wires that are in the range of applicable gauges.

*2 Remove insulation from the ends of wires to expose the length of wire shown.

*3 For wire gauges more than AWG 8, tighten to a tightening torque of 4.1 N·m to 4.5 N·m (36 in·lb to 40 in·lb).

*4 Terminals - and +1 have two screws. The Recommended Gauge is the wire gauge for one terminal.

*5 A junction terminal is necessary to connect a braking unit (CDBR-series) to terminals - and +3.

Three-Phase 400 V Class

Model	Terminal	Recommended Gauge AWG, kcmil	Applicable Gauge (IP20 Applicable Gauge ^{*1}) AWG, kcmil	Wire Stripping Length ^{*2} mm	Terminal Screw		Tightening Torque N·m (in·lb)
					Size	Shape	
4002	R/L1, S/L2, T/L3	14	14 - 6 (14 - 6)	10	M4	Slotted (-)	1.5 - 1.7 (13.5 - 15)
	U/T1, V/T2, W/T3	14	14 - 6 (14 - 6)	10	M4	Slotted (-)	1.5 - 1.7 (13.5 - 15)
	-, +1, +2	14	14 - 3 (14 - 3)	18	M5	Slotted (-)	2.3 - 2.5 (19.8 - 22) ^{*3}
	B1, B2	14	14 - 10 (14 - 10)	10	M4	Slotted (-)	1.5 - 1.7 (13.5 - 15)
	⊕	12	14 - 8 (-)	-	M4	Phillips/slotted combo	1.2 - 1.5 (10.6 - 13.3)
4004	R/L1, S/L2, T/L3	14	14 - 6 (14 - 6)	10	M4	Slotted (-)	1.5 - 1.7 (13.5 - 15)
	U/T1, V/T2, W/T3	14	14 - 6 (14 - 6)	10	M4	Slotted (-)	1.5 - 1.7 (13.5 - 15)
	-, +1, +2	14	14 - 3 (14 - 3)	18	M5	Slotted (-)	2.3 - 2.5 (19.8 - 22) ^{*3}
	B1, B2	14	14 - 10 (14 - 10)	10	M4	Slotted (-)	1.5 - 1.7 (13.5 - 15)
	⊕	12	14 - 8 (-)	-	M4	Phillips/slotted combo	1.2 - 1.5 (10.6 - 13.3)

7 Electrical Installation

Model	Terminal	Recommended Gauge AWG, kcmil	Applicable Gauge (IP20 Applicable Gauge ^{*1}) AWG, kcmil	Wire Stripping Length ^{*2} mm	Terminal Screw		Tightening Torque N-m (in-lb)
					Size	Shape	
4005	R/L1, S/L2, T/L3	14	14 - 6 (14 - 6)	10	M4	Slotted (-)	1.5 - 1.7 (13.5 - 15)
	U/T1, V/T2, W/T3	14	14 - 6 (14 - 6)	10	M4	Slotted (-)	1.5 - 1.7 (13.5 - 15)
	-, +1, +2	14	14 - 3 (14 - 3)	18	M5	Slotted (-)	2.3 - 2.5 (19.8 - 22) ^{*3}
	B1, B2	14	14 - 10 (14 - 10)	10	M4	Slotted (-)	1.5 - 1.7 (13.5 - 15)
	⊕	10	14 - 8 (-)	-	M4	Phillips/slotted combo	1.2 - 1.5 (10.6 - 13.3)
4007	R/L1, S/L2, T/L3	14	14 - 6 (14 - 6)	10	M4	Slotted (-)	1.5 - 1.7 (13.5 - 15)
	U/T1, V/T2, W/T3	14	14 - 6 (14 - 6)	10	M4	Slotted (-)	1.5 - 1.7 (13.5 - 15)
	-, +1, +2	14	14 - 3 (14 - 3)	18	M5	Slotted (-)	2.3 - 2.5 (19.8 - 22) ^{*3}
	B1, B2	14	14 - 10 (14 - 10)	10	M4	Slotted (-)	1.5 - 1.7 (13.5 - 15)
	⊕	10	14 - 8 (-)	-	M4	Phillips/slotted combo	1.2 - 1.5 (10.6 - 13.3)
4009	R/L1, S/L2, T/L3	14	14 - 6 (14 - 6)	10	M4	Slotted (-)	1.5 - 1.7 (13.5 - 15)
	U/T1, V/T2, W/T3	14	14 - 6 (14 - 6)	10	M4	Slotted (-)	1.5 - 1.7 (13.5 - 15)
	-, +1, +2	12	14 - 3 (14 - 3)	18	M5	Slotted (-)	2.3 - 2.5 (19.8 - 22) ^{*3}
	B1, B2	14	14 - 10 (14 - 10)	10	M4	Slotted (-)	1.5 - 1.7 (13.5 - 15)
	⊕	10	14 - 8 (-)	-	M4	Phillips/slotted combo	1.2 - 1.5 (10.6 - 13.3)
4012	R/L1, S/L2, T/L3	12	14 - 6 (14 - 6)	10	M4	Slotted (-)	1.5 - 1.7 (13.5 - 15)
	U/T1, V/T2, W/T3	14	14 - 6 (14 - 6)	10	M4	Slotted (-)	1.5 - 1.7 (13.5 - 15)
	-, +1, +2	10	14 - 3 (14 - 3)	18	M5	Slotted (-)	2.3 - 2.5 (19.8 - 22) ^{*3}
	B1, B2	14	14 - 10 (14 - 10)	10	M4	Slotted (-)	1.5 - 1.7 (13.5 - 15)
	⊕	10	14 - 8 (-)	-	M4	Phillips/slotted combo	1.2 - 1.5 (10.6 - 13.3)
4018	R/L1, S/L2, T/L3	10	14 - 6 (14 - 6)	10	M4	Slotted (-)	1.5 - 1.7 (13.5 - 15)
	U/T1, V/T2, W/T3	10	14 - 6 (14 - 6)	10	M4	Slotted (-)	1.5 - 1.7 (13.5 - 15)
	-, +1, +2	8	14 - 3 (14 - 3)	18	M5	Slotted (-)	2.3 - 2.5 (19.8 - 22) ^{*3}
	B1, B2	14	14 - 10 (14 - 10)	10	M4	Slotted (-)	1.5 - 1.7 (13.5 - 15)
	⊕	10	14 - 8 (-)	-	M5	Phillips/slotted combo	2.0 - 2.5 (17.7 - 22.1)

Model	Terminal	Recommended Gauge AWG, kcmil	Applicable Gauge (IP20 Applicable Gauge *) AWG, kcmil	Wire Stripping Length *2 mm	Terminal Screw		Tightening Torque N·m (in·lb)
					Size	Shape	
4023	R/L1, S/L2, T/L3	8	14 - 6 (14 - 6)	10	M4	Slotted (-)	1.5 - 1.7 (13.5 - 15)
	U/T1, V/T2, W/T3	10	14 - 6 (14 - 6)	10	M4	Slotted (-)	1.5 - 1.7 (13.5 - 15)
	-, +1, +2	8	14 - 3 (14 - 3)	18	M5	Slotted (-)	2.3 - 2.5 (19.8 - 22) *3
	B1, B2	12	14 - 10 (14 - 10)	10	M4	Slotted (-)	1.5 - 1.7 (13.5 - 15)
	⊕	10	12 - 8 (-)	-	M5	Phillips/slotted combo	2.0 - 2.5 (17.7 - 22.1)
4031	R/L1, S/L2, T/L3	6	14 - 3 (8 - 3)	18	M5	Slotted (-)	2.3 - 2.5 (19.8 - 22) *3
	U/T1, V/T2, W/T3	8	14 - 4 (10 - 4)	18	M5	Slotted (-)	2.3 - 2.5 (19.8 - 22) *3
	-, +1, +2	6	14 - 1 (8 - 1)	20	M6	Hex socket cap (WAF: 5 mm)	5 - 5.5 (45 - 49)
	B1, B2	10	14 - 8 (14 - 8)	10	M4	Slotted (-)	1.5 - 1.7 (13.5 - 15)
	⊕	8	10 - 6 (-)	-	M6	Phillips/slotted combo	5.4 - 6.0 (47.8 - 53.1)
4038	R/L1, S/L2, T/L3	6	14 - 3 (8 - 3)	18	M5	Slotted (-)	2.3 - 2.5 (19.8 - 22) *3
	U/T1, V/T2, W/T3	8	14 - 4 (10 - 4)	18	M5	Slotted (-)	2.3 - 2.5 (19.8 - 22) *3
	-, +1, +2	4	14 - 1 (8 - 1)	20	M6	Hex socket cap (WAF: 5 mm)	5 - 5.5 (45 - 49)
	B1, B2	10	14 - 8 (14 - 8)	10	M4	Slotted (-)	1.5 - 1.7 (13.5 - 15)
	⊕	6	10 - 6 (-)	-	M6	Phillips/slotted combo	5.4 - 6.0 (47.8 - 53.1)
4044	R/L1, S/L2, T/L3	4	14 - 4 (10 - 4)	18	M5	Slotted (-)	2.3 - 2.5 (19.8 - 22) *3
	U/T1, V/T2, W/T3	6	14 - 6 (10 - 6)	18	M5	Slotted (-)	2.3 - 2.5 (19.8 - 22) *3
	-, +1, +2	3	14 - 3 (10 - 3)	18	M5	Slotted (-)	2.3 - 2.5 (19.8 - 22) *3
	B1, B2	8	14 - 8 (14 - 8)	10	M4	Slotted (-)	1.5 - 1.7 (13.5 - 15)
	⊕	6	8 - 4 (-)	-	M6	Phillips/slotted combo	5.4 - 6.0 (47.8 - 53.1)
4060	R/L1, S/L2, T/L3	4	14 - 4 (10 - 4)	18	M5	Slotted (-)	2.3 - 2.5 (19.8 - 22) *3
	U/T1, V/T2, W/T3	4	14 - 4 (10 - 4)	18	M5	Slotted (-)	2.3 - 2.5 (19.8 - 22) *3
	-, +1	3	14 - 3 (10 - 3)	18	M5	Slotted (-)	2.3 - 2.5 (19.8 - 22) *3
	B1, B2	8	14 - 8 (14 - 8)	10	M4	Slotted (-)	1.5 - 1.7 (13.5 - 15)
	⊕	6	8 - 4 (-)	-	M6	Phillips/slotted combo	5.4 - 6.0 (47.8 - 53.1)

7 Electrical Installation

Model	Terminal	Recommended Gauge AWG, kcmil	Applicable Gauge (IP20 Applicable Gauge ^{*1}) AWG, kcmil	Wire Stripping Length ^{*2} mm	Terminal Screw		Tightening Torque N-m (in-lb)
					Size	Shape	
4075	R/L1, S/L2, T/L3	3	14 - 3 (12 - 3)	18	M5	Slotted (-)	2.3 - 2.5 (19.8 - 22) ^{*3}
	U/T1, V/T2, W/T3	3	14 - 3 (12 - 3)	18	M5	Slotted (-)	2.3 - 2.5 (19.8 - 22) ^{*3}
	-, +1	2	14 - 2 (10 - 2)	18	M5	Slotted (-)	2.3 - 2.5 (19.8 - 22) ^{*3}
	B1, B2	6	14 - 6 (14 - 6)	10	M4	Slotted (-)	1.5 - 1.7 (13.5 - 15)
	⊕	6	6 - 4 (-)	-	M6	Hex bolt (+)	5.4 - 6.0 (47.8 - 53.1)
4089	R/L1, S/L2, T/L3	2	14 - 2 (10 - 2)	18	M5	Slotted (-)	2.3 - 2.5 (19.8 - 22) ^{*3}
	U/T1, V/T2, W/T3	2	14 - 2 (10 - 2)	18	M5	Slotted (-)	2.3 - 2.5 (19.8 - 22) ^{*3}
	-, +1	1/0	14 - 1/0 (6 - 1/0)	20	M6	Hex socket cap (WAF: 5 mm)	5 - 5.5 (45 - 49)
	B1, B2	6	14 - 6 (14 - 6)	18	M5	Slotted (-)	2.3 - 2.5 (19.8 - 22) ^{*3}
	⊕	4	6 - 4 (-)	-	M6	Hex bolt (+)	5.4 - 6.0 (47.8 - 53.1)
4103	R/L1, S/L2, T/L3	1/0	6 - 2/0 (2 - 2/0)	27	M6	Hex socket cap (WAF: 5 mm)	8 - 9 (71 - 80)
	U/T1, V/T2, W/T3	1	6 - 2/0 (2 - 2/0)	27	M6	Hex socket cap (WAF: 5 mm)	8 - 9 (71 - 80)
	-, +1	2/0	2 - 4/0 (2 - 4/0)	27	M8	Hex socket cap (WAF: 6 mm)	10 - 12 (89 - 107)
	B1, B2	3	14 - 3 (10 - 3)	21	M6	Slotted (-)	3 - 3.5 (27 - 31)
	⊕	4	6 - 4 (-)	-	M6	Hex bolt (+)	5.4 - 6.0 (47.8 - 53.1)
4140	R/L1, S/L2, T/L3	3/0	2 - 250 (2/0 - 250)	37	M10	Hex socket cap (WAF: 8 mm)	12 - 14 (107 - 124)
	U/T1, V/T2, W/T3	2/0	2 - 300 (3/0 - 300)	37	M10	Hex socket cap (WAF: 8 mm)	12 - 14 (107 - 124)
	-, -, +1, +1 ^{*4}	2	6 - 2/0 (1/0 - 2/0)	28	M6	Hex socket cap (WAF: 5 mm)	8 - 9 (71 - 80)
	B1, B2 ^{*5}	1	4 - 2/0 (1 - 2/0)	28	M8	Hex socket cap (WAF: 6 mm)	8 - 9 (71 - 80)
	⊕	4	4 - 1/0 (-)	-	M8	Hex bolt (slotted)	9.0 - 11 (79.7 - 97.4)
4168	R/L1, S/L2, T/L3	4/0	2 - 250 (2/0 - 250)	37	M10	Hex socket cap (WAF: 8 mm)	12 - 14 (107 - 124)
	U/T1, V/T2, W/T3	4/0	2 - 300 (3/0 - 300)	37	M10	Hex socket cap (WAF: 8 mm)	12 - 14 (107 - 124)
	-, -, +1, +1 ^{*4}	1/0	6 - 2/0 (1/0 - 2/0)	28	M6	Hex socket cap (WAF: 5 mm)	8 - 9 (71 - 80)
	B1, B2 ^{*5}	1/0	4 - 2/0 (1 - 2/0)	28	M8	Hex socket cap (WAF: 6 mm)	8 - 9 (71 - 80)
	⊕	4	4 - 1/0 (-)	-	M8	Hex bolt (slotted)	9.0 - 11 (79.7 - 97.4)

Model	Terminal	Recommended Gauge AWG, kcmil	Applicable Gauge (IP20 Applicable Gauge *) AWG, kcmil	Wire Stripping Length *2 mm	Terminal Screw		Tightening Torque N·m (in·lb)
					Size	Shape	
4208	R/L1, S/L2, T/L3	1/0 × 2P	3 - 4/0 × 2P (2/0 - 4/0 × 2P)	-	M10	Hex self-locking nut	20 (177)
	U/T1, V/T2, W/T3	1/0 × 2P	3 - 4/0 × 2P (2/0 - 4/0 × 2P)	-	M10	Hex self-locking nut	20 (177)
	-, +1	3/0 × 2P	2 - 250 × 2P (4/0 - 250 × 2P)	-	M10	Hex self-locking nut	20 (177)
	+3	1/0 × 2P	4 - 1/0 × 2P (1/0 × 2P)	-	M10	Hex self-locking nut	20 (177)
	⊕	4	4 - 350 (-)	-	M10	Hex bolt (slotted)	18 - 23 (159 - 204)
4250	R/L1, S/L2, T/L3	2/0 × 2P	3 - 4/0 × 2P (2/0 - 4/0 × 2P)	-	M10	Hex self-locking nut	20 (177)
	U/T1, V/T2, W/T3	2/0 × 2P	3 - 4/0 × 2P (2/0 - 4/0 × 2P)	-	M10	Hex self-locking nut	20 (177)
	-, +1	3/0 × 2P	2 - 250 × 2P (4/0 - 250 × 2P)	-	M10	Hex self-locking nut	20 (177)
	+3	1/0 × 2P	4 - 1/0 × 2P (1/0 × 2P)	-	M10	Hex self-locking nut	20 (177)
	⊕	2	2 - 350 (-)	-	M10	Hex bolt (slotted)	18 - 23 (159 - 204)
4302	R/L1, S/L2, T/L3	3/0 × 2P	3 - 4/0 × 2P (2/0 - 4/0 × 2P)	-	M10	Hex self-locking nut	20 (177)
	U/T1, V/T2, W/T3	3/0 × 2P	3 - 4/0 × 2P (2/0 - 4/0 × 2P)	-	M10	Hex self-locking nut	20 (177)
	-, +1	4/0 × 2P	2 - 250 × 2P (4/0 - 250 × 2P)	-	M10	Hex self-locking nut	20 (177)
	+3	1/0 × 2P	4 - 1/0 × 2P (1/0 × 2P)	-	M10	Hex self-locking nut	20 (177)
	⊕	2	2 - 350 (-)	-	M10	Hex bolt (slotted)	18 - 23 (159 - 204)
4371	R/L1, S/L2, T/L3	250 × 2P	2/0 - 300 × 2P (250 - 300 × 2P)	-	M12	Hex self-locking nut	35 (310)
	U/T1, V/T2, W/T3	250 × 2P	2/0 - 300 × 2P (250 - 300 × 2P)	-	M12	Hex self-locking nut	35 (310)
	-, +1	350 × 2P	4/0 - 400 × 2P (300 - 400 × 2P)	-	M12	Hex self-locking nut	35 (310)
	+3	3/0 × 2P	1 - 4/0 × 2P (-)	-	M12	Hex self-locking nut	35 (310)
	⊕	1	1 - 350 (-)	-	M12	Hex bolt (slotted)	32 - 40 (283 - 354)
4414	R/L1, S/L2, T/L3	300 × 2P	2/0 - 300 × 2P (250 - 300 × 2P)	-	M12	Hex self-locking nut	35 (310)
	U/T1, V/T2, W/T3	300 × 2P	2/0 - 300 × 2P (250 - 300 × 2P)	-	M12	Hex self-locking nut	35 (310)
	-, +1	400 × 2P	4/0 - 400 × 2P (300 - 400 × 2P)	-	M12	Hex self-locking nut	35 (310)
	+3	4/0 × 2P	1 - 4/0 × 2P (-)	-	M12	Hex self-locking nut	35 (310)
	⊕	1	1 - 350 (-)	-	M12	Hex bolt (slotted)	32 - 40 (283 - 354)

Model	Terminal	Recommended Gauge AWG, kcmil	Applicable Gauge (IP20 Applicable Gauge ^{*1}) AWG, kcmil	Wire Stripping Length ^{*2} mm	Terminal Screw		Tightening Torque N·m (in·lb)
					Size	Shape	
4477	R/L1, S/L2, T/L3	250 × 4P	2/0 - 300 × 4P (250 - 300 × 4P)	-	M12	Hex self-locking nut	35 (310)
	U/T1, V/T2, W/T3	4/0 × 4P	2/0 - 300 × 4P (250 - 300 × 4P)	-	M12	Hex self-locking nut	35 (310)
	-, +1	4/0 × 4P	3/0 - 400 × 4P (300 - 400 × 4P)	-	M12	Hex self-locking nut	35 (310)
	+3	3/0 × 4P	2 - 4/0 (4/0 × 4P)	-	M12	Hex self-locking nut	35 (310)
	⊕	1/0	1/0 - 300 (-)	-	M12	Hex bolt (slotted)	32 - 40 (283 - 354)
4568	R/L1, S/L2, T/L3	250 × 4P	2/0 - 300 × 4P (250 - 300 × 4P)	-	M12	Hex self-locking nut	35 (310)
	U/T1, V/T2, W/T3	4/0 × 4P	2/0 - 300 × 4P (250 - 300 × 4P)	-	M12	Hex self-locking nut	35 (310)
	-, +1	300 × 4P	3/0 - 400 × 4P (300 - 400 × 4P)	-	M12	Hex self-locking nut	35 (310)
	+3	3/0 × 4P	2 - 4/0 × 4P (4/0 × 4P)	-	M12	Hex self-locking nut	35 (310)
	⊕	2/0	2/0 - 300 (-)	-	M12	Hex bolt (slotted)	32 - 40 (283 - 354)
4605	R/L1, S/L2, T/L3	300 × 4P	2/0 - 300 × 4P (250 - 300 × 4P)	-	M12	Hex self-locking nut	35 (310)
	U/T1, V/T2, W/T3	300 × 4P	2/0 - 300 × 4P (250 - 300 × 4P)	-	M12	Hex self-locking nut	35 (310)
	-, +1	400 × 4P	3/0 - 400 × 4P (300 - 400 × 4P)	-	M12	Hex self-locking nut	35 (310)
	+3	4/0 × 4P	2 - 4/0 × 4P (4/0 × 4P)	-	M12	Hex self-locking nut	35 (310)
	⊕	2/0	2/0 - 300 (-)	-	M12	Hex bolt (slotted)	32 - 40 (283 - 354)
4720	R/L1, S/L2, T/L3	300 × 4P	2/0 - 300 × 4P (250 - 300 × 4P)	-	M12	Hex self-locking nut	35 (310)
	U/T1, V/T2, W/T3	300 × 4P	2/0 - 300 × 4P (250 - 300 × 4P)	-	M12	Hex self-locking nut	35 (310)
	-, +1	400 × 4P	3/0 - 400 × 4P (300 - 400 × 4P)	-	M12	Hex self-locking nut	35 (310)
	+3	4/0 × 4P	2 - 4/0 × 4P (4/0 × 4P)	-	M12	Hex self-locking nut	35 (310)
	⊕	2/0	2/0 - 300 (-)	-	M12	Hex bolt (slotted)	32 - 40 (283 - 354)

- *1 For IP20 protection, use wires that are in the range of applicable gauges.
- *2 Remove insulation from the ends of wires to expose the length of wire shown.
- *3 For wire gauges more than AWG 8, tighten to a tightening torque of 4.1 N·m to 4.5 N·m (36 in·lb to 40 in·lb).
- *4 Terminals - and +1 have two screws. The Recommended Gauge is the wire gauge for one terminal.
- *5 A junction terminal is necessary to connect a braking resistor unit (LKEB-series) to terminals B1 and B2.

◆ Main Circuit Terminal Block Wiring Procedure

⚠ DANGER *Electrical Shock Hazard. Do not examine, connect, or disconnect wiring on an energized drive. Before servicing, disconnect all power to the equipment and wait for the time specified on the warning label at a minimum. The internal capacitor stays charged after the drive is de-energized. The charge indicator LED extinguishes when the DC bus voltage decreases below 50 Vdc. When all indicators are OFF, remove the covers before measuring for dangerous voltages to make sure that the drive is safe. If you do work on the drive when it is energized, it will cause serious injury or death from electrical shock. The drive has internal capacitors that stay charged after you de-energize the drive.*

The procedures to wire the main circuit terminal block are different for different drive models. Refer to [Table 7.2](#) for procedures by drive model.

Table 7.2 Types of Wiring Procedure for the Main Circuit Terminal Block

Model	Procedure	Reference
2004 - 2211 4002 - 4168	Procedure A	37
2257 - 2415 4208 - 4720	Procedure B	41

■ Wiring the Main Circuit Terminal Block Using Procedure A

Notes on Wiring the Main Circuit Terminal Block

Read these notes before you wire the main circuit terminal block.

Note:

- Use UL-Listed, vinyl-coated insulated copper wires for operation with a continuous maximum permitted temperature of 75 °C at 600 V
- Remove all unwanted objects that are near the terminal block connections.
- Remove the insulation from the connection wires to the wire stripping lengths shown in the manual.
- Do not use bent or crushed wires. Remove the damaged end of the wire before you use it. Incorrect connections can cause death or serious injury from fire.
- Do not solder stranded wire. Soldered wire connections can become loose over time and cause unsatisfactory drive performance.
- If you use stranded wire, make sure that all of the wire strands are in the connection. Also, do not twist the stranded wire too much. Incorrect connections can cause death or serious injury from fire.
- Put the wire all the way into the terminal block. Remove the insulation from the wire to the recommended wire stripping length to fit the wire with insulation in the plastic housing.
- Use a torque driver, torque ratchet, or torque wrench for the screws. A slotted driver or a hex tool will be necessary to wire the screw clamp terminal. Use applicable tools as specified by the recommended conditions in the product manual.
- If you use power tools to tighten the terminal screws, use a low speed setting (300 to 400 r/min). Failure to obey can cause damage to the terminal screws.
- Users can purchase wiring tools from Yaskawa. Contact Yaskawa or your nearest sales representative for more information.
- Wire gauges on existing drive models to be replaced may not match wire gauge ranges on new drives. Contact Yaskawa or your nearest sales representative for more information about the connection procedures.
- Do not tighten the terminal screws at an angle of 5 degrees or more. Failure to obey can cause damage to the terminal screws.

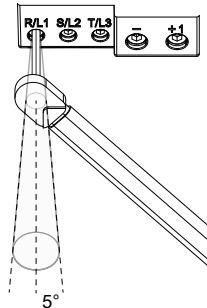

Figure 7.3 Permitted Angle

- Put the bit all the way into the hex socket to tighten the hex socket cap screw.
- When tightening slotted screws, hold the straight-edge screwdriver perpendicularly to the screw. Take care to ensure that the tip of the straight-edge screwdriver is aligned with the screw groove.

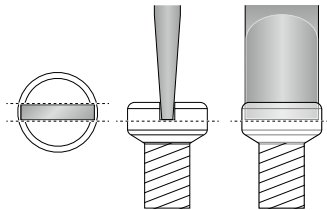
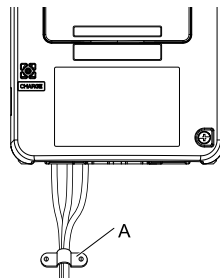

Figure 7.4 Tightening Slotted Screws

- After connecting the wires to the terminal block, lightly pull on the wires to make sure that they do not come out of the terminals.
- Remove the correct section of the wiring cover to make wiring easier.
- Do not let strain on the wiring cause damage. Use a strain relief near the wiring to release the tension. Refer to [Figure 7.5](#) for an example.



A - Cable clamp

Figure 7.5 Strain Relief Example

Table 7.3 Recommended Wiring Tools

Screw Size	Screw Shape	Adapter	Bit		Torque Driver Model (Tightening Torque)	Torque Wrench
			Model	Manufacturer		
M4	Slotted (-)	Bit	SF-BIT-SL 1,0X4,0-70	PHOENIX CONTACT	TSD-M 3NM (1.2 - 3 N·m (10.6 - 26.6 in·lb))	-
M5 ^{*1}	Slotted (-)	Bit	SF-BIT-SL 1,2X6,5-70	PHOENIX CONTACT	Wire Gauge ≤ 25 mm ² (AWG 10): TSD-M 3NM (1.2 - 3 N·m (10.6 - 26.6 in·lb))	Wire Gauge ≤ 25 mm ² (AWG 10): -
					Wire Gauge ≥ 30 mm ² (AWG 8): -	Wire Gauge ≥ 30 mm ² (AWG 8): 4.1 - 4.5 N·m (36.3 - 39.8 in·lb) ^{*2 *3}
M6	Hex socket cap (WAF: 5 mm)	Bit	SF-BIT-HEX 5-50	PHOENIX CONTACT	-	5 - 9 N·m (44.3 - 79.9 in·lb) ^{*2 *3}
	Slotted (-)	Bit	SF-BIT-SL 1,2X6,5-70	PHOENIX CONTACT	-	3 - 3.5 N·m (26.6 - 31.0 in·lb) ^{*2 *3}
M8	Hex socket cap (WAF: 6 mm)	Bit	SF-BIT-HEX 6-50	PHOENIX CONTACT	-	8 - 12 N·m (70.8 - 106.2 in·lb) ^{*2 *3}
M10	Hex socket cap (WAF: 8 mm)	Bit	SF-BIT-HEX 8-50	PHOENIX CONTACT	-	12 - 14 N·m (106.2 - 123.9 in·lb) ^{*2 *3}

*1 When wiring drive models 2056 and 4089 and smaller, select the correct tools for the wire gauge.

*2 Use 6.35 mm (0.25 in) bit socket holder.

*3 Use a torque wrench that can apply this torque measurement range.

Main Circuit Terminal Block Wiring Procedure

Remove the keypad and front cover before wiring the main circuit terminal block.

1. Pull the wiring cover away from the drive to remove it.

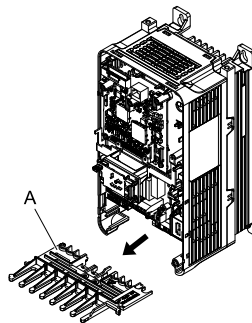

A - Wiring cover

Figure 7.6 Remove the Wiring Cover

- Put the end of a prepared wire into the terminal block.

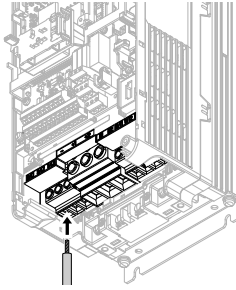

Figure 7.7 Install the Electrical Wire

Note:

If there is a jumper between terminals +1 and +2, loosen the terminal block screws and remove the jumper before wiring the terminals.

- Tighten the screws to the specified torque.

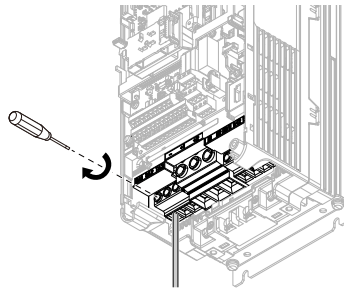
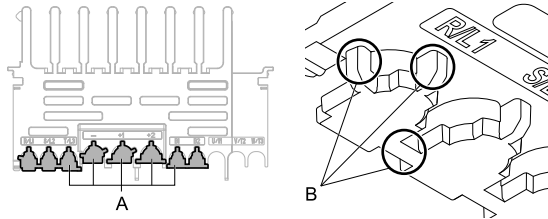

Figure 7.8 Tighten Terminal Block Screws

- Examine the signal from the wired terminal and use a diagonal-cutting pliers to remove areas of the wiring cover cutaway section.

To remove the wiring cover, cut off the portion shown in [Figure 7.9](#).



A - Cutaway sections

B - Cut this portion with a diagonal-cutting pliers

Figure 7.9 Clip the Cutaway Section of the Wiring Cover

Note:

- Different drive models have different wiring cover shapes.
- Only clip the section of the wiring cover that applies to the wired terminal. If you clip areas that do not apply to wired terminals, the protective enclosure will not keep its IP20 protective level.
- Tightly hold the cutaway section when removing pieces of the cutaway section. Pieces of the cutaway section can fly out and cause injury.
- Make sure that the clipped section does not cause damage to the wires.
- If you use wires that are not specified by Yaskawa, the protective enclosure could lose its IP20 protective level, although the wiring cover is correct. Contact Yaskawa or your nearest sales representative for more information.

- Put the wiring cover in its initial position. Put the cables through the holes cut from the wiring cover.

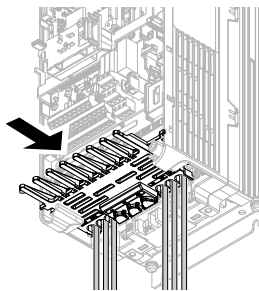

Figure 7.10 Reattach the Wiring Cover

- Install the front cover and the keypad to their initial positions.

■ Wiring the Main Circuit Terminal Block Using Procedure B

Notes on Wiring the Main Circuit Terminal Block

Note:

- After you connect the wire to the terminal, do not twist or move it too much.
- Be sure to use only wires with the correct size, stripped wire length, and tightening torque as specified by Yaskawa.
- Use tools that fit the shape of the screw head to tighten and loosen the terminal block screws.
- Make sure that there are no loose stranded wires or frayed wires after wiring is complete.

Main Circuit Terminal Block Wiring Procedure

Remove the terminal cover before wiring the main circuit terminal block.

- Remove the screws on the terminal block cover and pull the terminal block cover away from the drive. Pull the wiring cover away from the drive to remove the wiring cover after removing the terminal block cover.

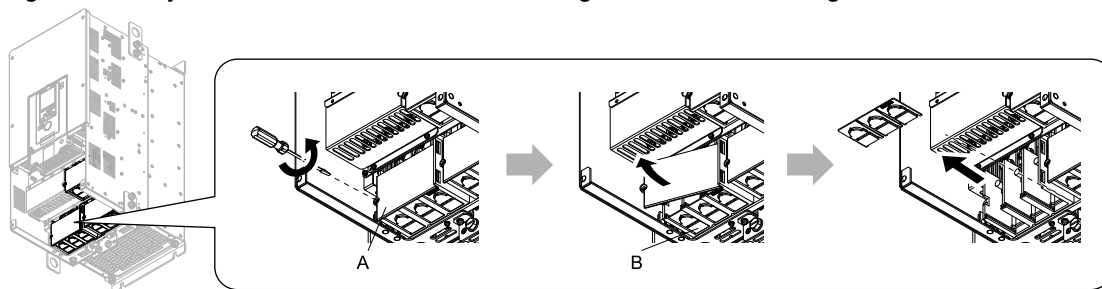

A - Terminal block cover

B - Wiring cover

Figure 7.11 Remove the Wiring Cover

- Remove the terminal block nut.

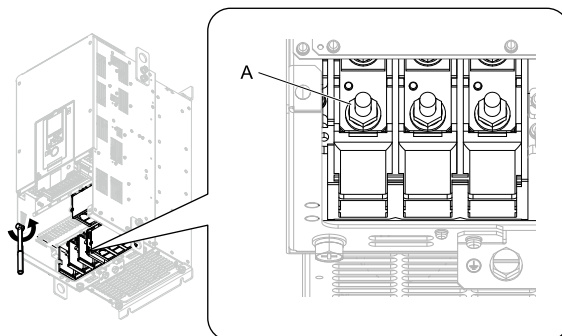

A - Nut

Figure 7.12 Remove the Terminal Block Nut

3. Wire the closed-loop crimp terminal to the main circuit terminal block.

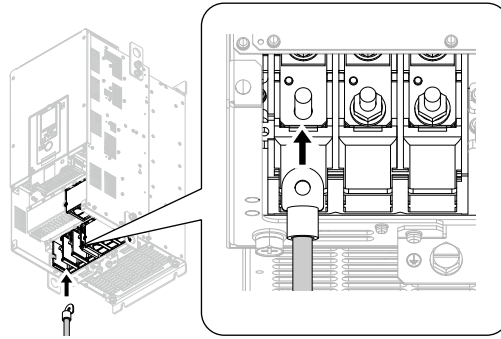

Figure 7.13 Install the Electrical Wire

4. Tighten the nut to the specified torque.

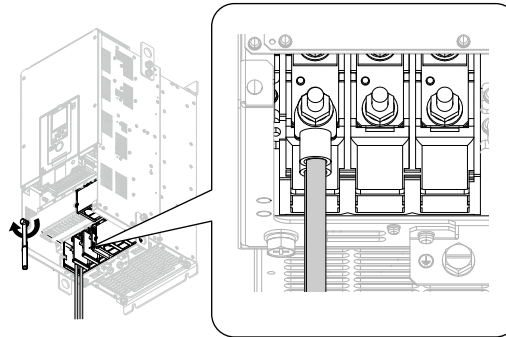
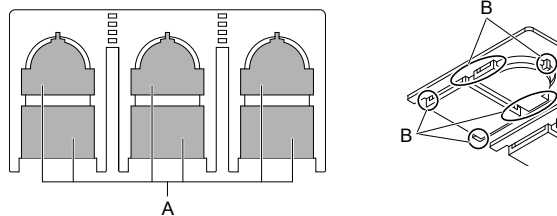

Figure 7.14 Tighten the Terminal Block Nut

5. Check the signal from the wired terminal and use a diagonal-cutting pliers to remove areas of the wiring cover cutaway section.

Cut the areas shown in [Figure 7.15](#).



A - Cutaway section

B - Use a diagonal-cutting pliers to clip this area.

Figure 7.15 Clip the Cutaway Section of the Wiring Cover

Note:

- Different drive models have different wiring covers.
- Remove only the areas from the wiring cover that apply to the wired terminal. If you remove areas that do not apply to the wired terminal, the drive will not keep its IP20 protective level.
- Make sure that you hold the cutaway section tightly when you remove pieces of the cutaway section. Pieces of the cutaway section can fly out and cause injury.
- Remove sharp edges from the wiring cover cutaway section to prevent damage to the wires.
- If you use the wiring cover correctly, but you use wires that are not specified by Yaskawa, the drive will not necessarily keep its IP20 protective level.
- When you use the recommended gauge for the electrical wires, it is not necessary to attach the wiring cover of the main circuit power input terminal and the drive output terminal. If you use the applicable gauge for the electrical wires, you must attach the wiring cover.

- Attach the wiring cover and terminal block cover to their initial positions and tighten the screws on the terminal block cover.

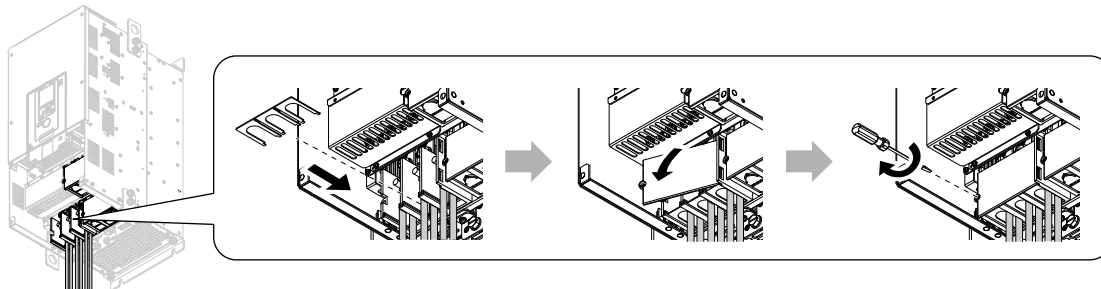

Figure 7.16 Reattach the Wiring Cover

- Put the terminal cover back in its initial position.

8 Keypad: Names and Functions

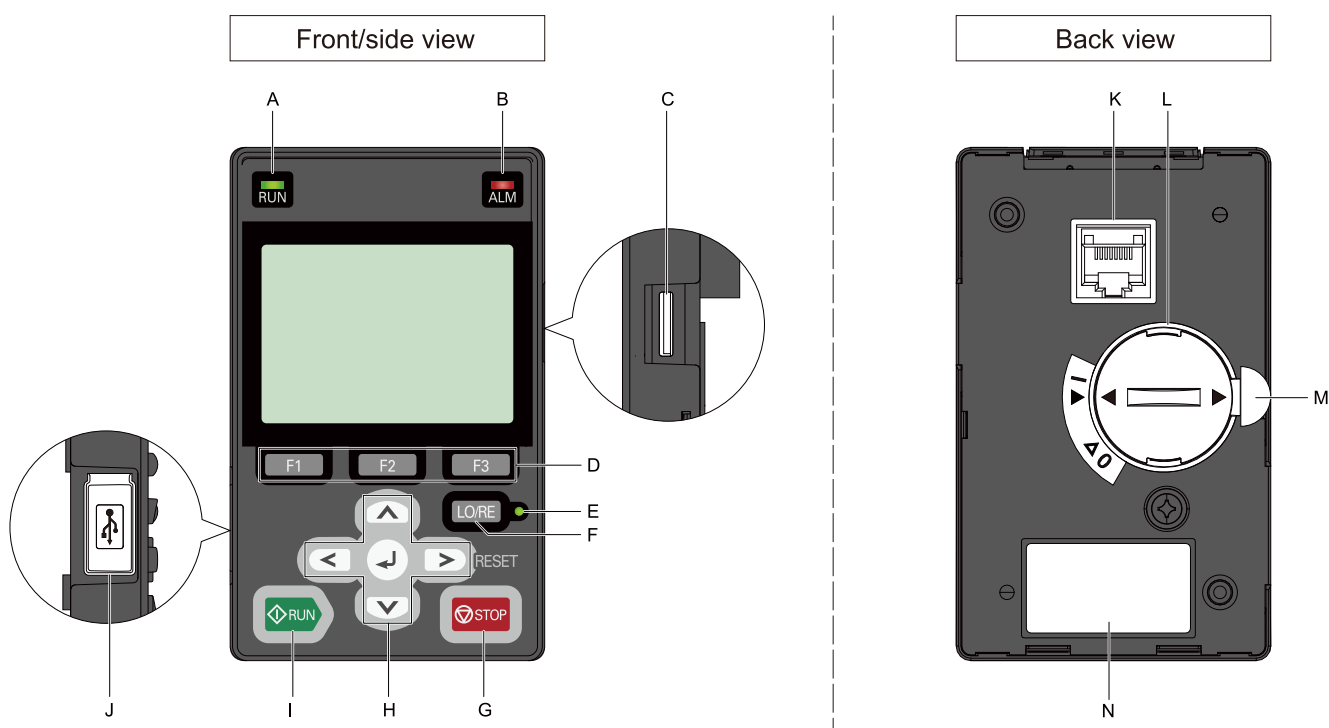

















Figure 8.1 Keypad

Table 8.1 Keypad: Names and Functions

No.	Name	Function
A	<p>RUN LED</p> 	<p>Illuminates to show that the drive is operating the motor. The LED turns OFF when the drive stops.</p> <p>Flashes to show that:</p> <ul style="list-style-type: none"> The drive is decelerating to stop. The drive received a Run command but the frequency reference is 0 Hz. <p>Flashes quickly to show that:</p> <ul style="list-style-type: none"> The drive received a Run command from the Multi-Function Digital Input (MFDI) terminals and is switching to REMOTE Mode while the drive is in LOCAL Mode. The drive received a Run command from the MFDI terminals when the drive is not in Drive Mode. The drive received a Fast Stop command. The safety function shuts off the drive output. <ul style="list-style-type: none"> The user pushed  on the keypad while the drive is operating in REMOTE Mode. The drive is energized with an active Run command and $b1-17 = 0$ [Run Command at Power Up = Disregard Existing RUN Command].
B	<p>ALM LED</p> 	<p>Illuminates when the drive detects a fault. Flashes when the drive detects:</p> <ul style="list-style-type: none"> Alarm An oPE parameter setting error A fault or alarm during Auto-Tuning <p>The light switches off when the drive is in normal operation. There is no fault or alarm.</p>
C	microSD Card Insertion Slot	The insertion point for a microSD card.
D	<p>Function Keys (F1, F2, F3)</p> 	<p>The menu shown on the keypad sets the functions for function keys. The name of each function is in the lower half of the display window.</p>
E	<p>LO/RE LED</p> 	<p>Illuminated: The keypad controls the Run command (LOCAL Mode). OFF: The control circuit terminal or serial transmission device controls the Run command (REMOTE Mode).</p> <p>Note:</p> <ul style="list-style-type: none"> LOCAL: Operated using the keypad. Use the keypad to enter Run/Stop commands and the frequency reference command. REMOTE: Operated from the control circuit terminal or serial transmission. Use the frequency reference source entered in $b1-01$ and the Run command source selected in $b1-02$.
F	<p>LO/RE Selection Key</p> 	<p>Switches drive control for the Run command and frequency reference between the keypad (LOCAL) and an external source (REMOTE).</p> <p>Note:</p> <ul style="list-style-type: none"> Stop operation to enable the LO/RE Selection Key when in Drive Mode. Set $o2-01 = 0$ [LO/RE Key Function Selection = Disabled] to disable  when switching from REMOTE to LOCAL will have a negative effect on system performance. The drive will not switch between LOCAL and REMOTE when it is receiving a Run command from an external source.
G	<p>STOP Key</p> 	<p>Stops drive operation.</p> <p>Note:</p> <p>The STOP key has highest priority. Push  to stop the motor even when a Run command (REMOTE Mode) is active at any external Run command source. Set $o2-02 = 0$ [STOP Key Function Selection = Disabled] to disable the priority in .</p>
H	<p>Left Arrow Key</p> 	Moves the cursor to the left.
	<p>Up Arrow Key/Down Arrow Key</p> 	<ul style="list-style-type: none"> Scrolls up or down to display the next item or the previous item. Selects parameter numbers, and increments or decrements setting values.
	<p>Right Arrow Key (RESET)</p> 	<ul style="list-style-type: none"> Moves the cursor to the right. Continues to the next screen. Clears drive faults.
	<p>ENTER Key</p> 	<ul style="list-style-type: none"> Enters parameter values and settings. Selects menu items to move the user between keypad displays. Selects each mode, parameter, and set value.
I	<p>RUN Key</p> 	<p>Starts the drive in LOCAL mode. Starts the motor tuning procedure in Auto-Tuning Mode.</p> <p>Note:</p> <p>Push  on the keypad to set the drive to LOCAL Mode before using the keypad to operate the motor.</p>
J	USB Terminal	Insertion point for a mini USB cable. Uses a USB cable (USB standard 2.0, type A - mini-B) to connect the keypad to a PC.
K	RJ-45 Connector	Connects to the drive using an RJ-45 8-pin straight through UTP CAT5e extension cable or keypad connector.

No.	Name	Function
L	Clock Battery Cover	Cover for the clock battery. Note: <ul style="list-style-type: none"> • The battery included with the keypad is for operation check. It may be exhausted earlier than the expected battery life described in the manual. • Refer to "Maintenance & Troubleshooting Manual (TOEPAIGA8001)" for details on replacement procedure. To replace the battery, use a Hitachi Maxell "CR2016 Lithium Manganese Dioxide Lithium Battery" or an equivalent battery with these properties: <ul style="list-style-type: none"> • Nominal voltage: 3 V • Operating temperature range: -20°C to +85°C (-4°F to +185°F)
M	Insulation Sheet	An insulating sheet is attached to the keypad battery to prevent battery drain. Remove the insulation sheet before you use the keypad for the first time.
N	Name Plate	Shows the model, lot number, and FLASH number of the keypad. Note: Make sure that you use a keypad with FLASH number 1004 or later. Keypads with FLASH numbers 1003 and earlier will not show characters correctly.

⚠ WARNING *Sudden Movement Hazard. If you change the control source when b1-07 = 1 [LOCAL/REMOTE Run Selection = Accept Existing RUN Command], the drive can start suddenly. Before you change the control source, remove all personnel from the area around the drive, motor, and load. Sudden starts can cause serious injury or death.*

◆ Keypad Mode and Menu Displays

10:00 am	FWD	Rdy	Home
Freq Reference (AI)			
U1-01	Hz		0.00
Output Frequency			
U1-02	Hz		0.00
Output Current			
U1-03	A		0.00
Menu			

HOME

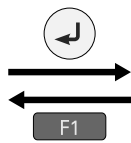
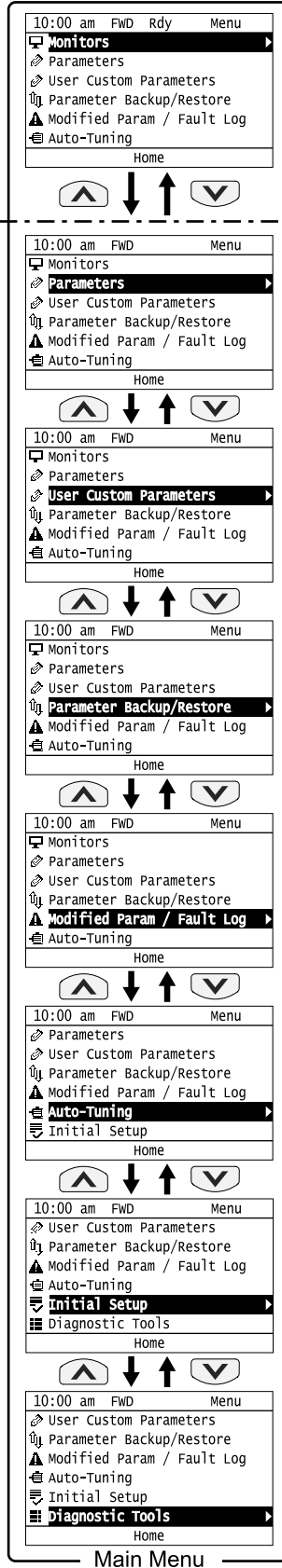
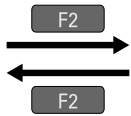

10:00 am	FWD	Rdy	Monitor
Standard Monitor			
Custom Monitor			
Bar Graph			
Analog Gauge			
Trend Plot			
Back		Home	

Monitors

Drive Mode

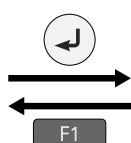

10:00 am	FWD	Parameters
Initialization Parameters		
Application		
Tuning		
References		
Motor Parameters		
Options		
Back		Home

Parameters

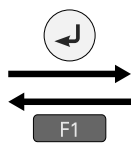

10:00 am	FWD	Parameters
Application Preset		
A1-06	0	(0)
Control Method Selection		
A1-02	2	(2)
Frequency Reference Selection 1		
b1-01	1	(1)
Back		Home

User Custom Parameters

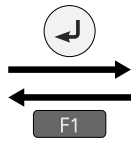

10:00 am	FWD	Backup
Select Items to Backup/Restore		
Standard Parameters		
Back		Home

Parameter Backup/Restore

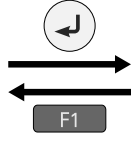

10:00 am	FWD	History
Modified Parameters		
Fault Log		
Back		Home

Modified Parameters/Fault Log

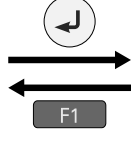

10:00 am	FWD	Auto Tuning
Select Auto-Tuning mode		
Motor Parameter Tuning		
Back		Home

Auto-Tuning

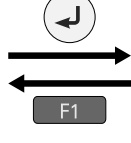

10:00 am	FWD	Init Setup
Language Selection		
Set Date/Time		
Setup Wizard		
Show Initial Setup Screen		
Back		Home

Initial Setup

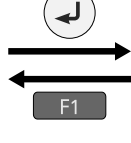

10:00 am	FWD	Tools
Data Logger		
Backlight		
Drive Information		
Back		Home
		Setup

Diagnostic Tools

Programming Mode

Figure 8.2 Keypad Functions and Display Levels

Note:



- Energize the drive with factory defaults to show the Initial Setup screen. Push **F2** (Home) to show the HOME screen.
 - Select [No] from the [Show Initial Setup Screen] setting to not display the Initial Setup screen.
- Push  from the Home screen to show drive monitors.
- Push  to set *d1-01 [Reference 1]* when the Home screen shows *U1-01 [Frequency Reference]* in LOCAL Mode.
- The keypad will show [Rdy] when the drive is in Drive Mode. The drive is prepared to accept a Run command.
- The drive will not accept a Run command in Programming Mode in the default setting. Set *b1-08 [Run Command Select in PRG Mode]* to accept or reject a Run command from an external source while in Programming Mode.
 - Set *b1-08 = 0 [Disregard RUN while Programming]* to reject the Run command from an external source while in Programming Mode (default).
 - Set *b1-08 = 1 [Accept RUN while Programming]* to accept the Run command from an external source while in Programming Mode.
 - Set *b1-08 = 2 [Allow Programming Only at Stop]* to prevent changes from Drive Mode to Programming Mode while the drive is operating.

Table 8.2 Drive Mode Screens and Functions

Mode	Keypad Screen	Function
Drive Mode	Monitors	Sets monitor items to display.
Programming Mode	Parameters	Changes parameter settings.
	User Custom Parameters	Shows the User Parameters.
	Parameter Backup/Restore	Saves parameters to the keypad as backup.
	Modified Parameters/Fault Log	Shows modified parameters and fault history.
	Auto-Tuning	Auto-Tunes the drive.
	Initial Setup	Changes initial settings.
	Diagnostic Tools	Sets data logs and backlight.

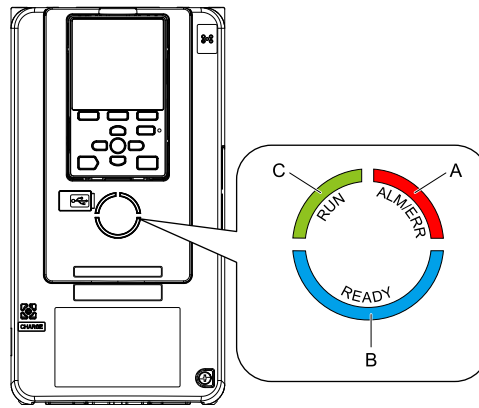

9 LED Status Ring

The LED Status Ring on the drive cover shows the drive operating status.



A - ALM/ERR
B - Ready

C - RUN

LED	Status	Description	
A	ALM/ERR	Illuminated	The drive detects a fault.
		Flashing ^{*1}	The drive detects: <ul style="list-style-type: none"> An alarm An oPE parameter setting error An Auto-Tuning error Note: The LED will illuminate to identify a fault if the drive detects a fault and an alarm at the same time.
		OFF	There are no drive faults or alarms.
B	Ready	Illuminated	The drive is operating or is prepared for operation.
		Flashing ^{*1}	The drive is in <i>STo</i> [<i>Safe Torque OFF</i>] condition.
		Flashing Quickly ^{*1}	The voltage of the main circuit power supply dropped, and only the external 24 V power supply provides the power to the drive.
		OFF	<ul style="list-style-type: none"> The drive detects a fault. There is no fault and the drive received a Run command, but the drive cannot operate. For example, in Programming Mode or when  is flashing.
C	RUN	Illuminated	The drive is in regular operation.
		Flashing ^{*1}	<ul style="list-style-type: none"> The drive is decelerating to stop. The drive received a Run command with a frequency reference of 0 Hz, but the drive is not set for zero speed control. The drive received a DC Injection Braking command.
		Flashing Quickly ^{*1}	<ul style="list-style-type: none"> The drive received a Run command from the MFDI terminals and is switching to REMOTE Mode while the drive is in LOCAL Mode. The drive received a Run command from the MFDI terminals when the drive is not in Drive Mode. The drive received a Fast Stop command. The safety function shuts off the drive output. The user pushed  on the keypad while the drive is operating in REMOTE Mode. The drive is energized with an active Run command and <i>b1-17 = 0</i> [<i>Run Command at Power Up = Disregard Existing RUN Command</i>]. The drive is set to coast-to-stop with timer (<i>b1-03 = 3</i> [<i>Stopping Method Selection = Coast to Stop with Timer</i>]), and the Run command is disabled then enabled during the Run wait time.
		OFF	The motor is stopped.

*1 Refer to [Figure 9.1](#) for the difference between “flashing” and “flashing quickly”.

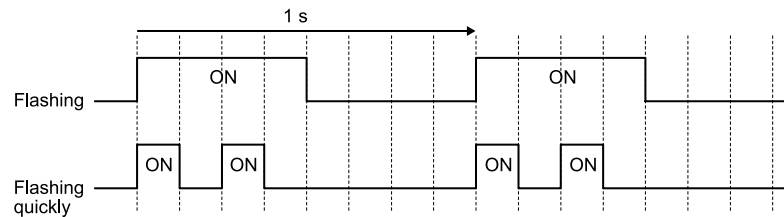

Figure 9.1 LED Flashing Statuses

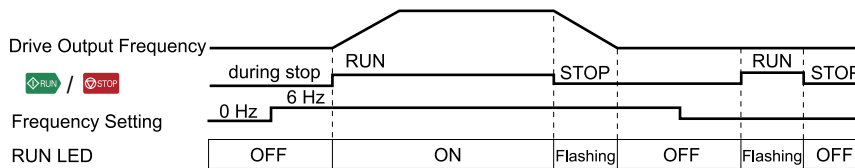

Figure 9.2 Relation between RUN LED and Drive Operation

10 Drive Start-Up Procedure

1. Install and wire the drive.
 2. Energize the drive.
 3. Use A1-06 [Application Preset] to initialize the drive for a special application if necessary.
 4. Run the Setup Wizard to automatically set these functions:
 - Control method selection
 - HD/ND selection
 - Motor data
 - Frequency reference
 - Run command source
 - Acceleration and deceleration times
 5. Run the motor without a load.
 6. Make sure that the drive is operating correctly and make sure that the host controller is sending commands to the drive.
 7. Connect the load.
 8. Run the motor.
 9. Make sure that the drive is operating correctly.
 10. Fine-tune and set application parameters, such as PID.
 11. Do a final operation check and make sure that parameter settings are correct.
- The drive is prepared to run the operation.

◆ Setup Wizard

Refer to the motor nameplate and record the information in this table before you start the drive.

Item	Value
Motor Rated Power	kW
Motor Rated Voltage	V
Motor Rated Current	A
Motor Rated Frequency	Hz
Motor Maximum Frequency	Hz
Number of Motor Poles	Poles

10 Drive Start-Up Procedure

Item	Value
Motor Base Rotation Speed	min ⁻¹ (r/min)
Number of Motor Encoder Pulses	ppr

The drive setup wizard prepares the drive for operation. Use the information from the table for Auto-Tuning and test runs.

1. Energize the drive to show the initial setup screen.

Note:

If the keypad does not show the Initial Setup screen, push **F2** (Menu) to show the Menu screen then push **▲** to select [Initial Setup].

2. Select [Set Date/Time] to set the date and time.

Note:

Open the clock battery cover to put in a battery to use the clock functions. Use a Hitachi Maxell CR2016 manganese dioxide lithium battery or an equivalent battery with these properties:

- Nominal voltage: 3 V
- Operating temperature range: -20 °C to +85 °C (-4 °F to +185 °F)
- Nominal battery life: 2 years (20 °C (68 °F) ambient temperature)

3. Select [Setup Wizard] and follow the instructions shown on the keypad until the setup wizard completes.

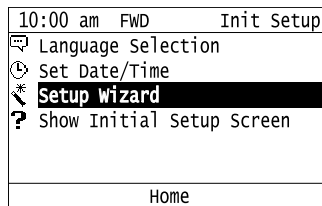

The drive and motor are prepared for operation.

Note:

Refer to [Disable the Initial Setup Screen on page 52](#) to stop showing the Initial Setup screen when you energize the drive.

◆ Change Parameter Settings

This example shows how to change the setting value for *C1-01 [Acceleration Time 1]*. Do the steps in this procedure to set parameters for the application.

1. Push **F2** (Home) to show the HOME screen.

Note:

- When the drive is in HOME Mode, the screen shows [Home] in the upper right-hand corner of the screen.
- If [Home] is not shown above the **F2**, push **F1** (Back).

2. Push **F2** (Menu).

10:00 am FWD Rdy	Home
Freq Reference (AI)	
U1-01 Hz	0.00
Output Frequency	
U1-02 Hz	0.00
Output Current	
U1-03 A	0.00
Menu	

3. Push  or  to select [Parameters], then push .



10:00 am	FWD	Menu
Monitors		
Parameters		
User Custom Parameters		
Parameter Backup/Restore		
Modified Param / Fault Log		
Auto-Tuning		
Home		

4. Push  or  to select [C Tuning], then push .





10:00 am	FWD	Parameters
A Initialization Parameters		
b Application		
C Tuning		
d References		
E Motor Parameters		
F Options		
Back		Home

5. Push  or  to select [C1 Accel & Decel Time], then push .



10:00 am	FWD	Parameters
C1 Accel & Decel Time		
C2 S-Curve Characteristics		
C3 Slip Compensation		
C4 Torque Compensation		
C6 Duty & Carrier Frequency		
Back		Home

6. Push  or  to select C1-01, then push .

10:00 am	FWD	Parameters
Acceleration Time 1		
C1-01	10.0	(10.0)sec
Deceleration Time 1		
C1-02	10.0	(10.0)sec
Acceleration Time 2		
C1-03	10.0	(10.0)sec
Back		Home

7. Push  or  to select the specified digit, then push  or  to select the correct number.

10:00 am	FWD	Parameters
Acceleration Time 1		
C1-01	0010.0sec	
Default : 10.0sec		
Range : 0.0~6000.0		
Back		Default Min/Max

- Push  [Default] to set the parameters to factory defaults.
- Push  [Min/Max] to show the minimum value or the maximum value on the display.

8. Push  to keep the changes.

10:00 am	FWD	Parameters
Acceleration Time 1		
C1-01	0020.0 sec	
Default : 10.0 sec		
Range : 0.0~6000.0		
Back		Default Min/Max

9. Continue to change parameters, then push  [Back],  [Home] to go back to the home screen after you change all the applicable parameters.

◆ Disable the Initial Setup Screen

Do the steps in this procedure to not show the initial start-up screen when the drive is energized.

1. Push **F2** (Home) to show the HOME screen.

Note:

- When the drive is in HOME Mode, the screen shows [Home] in the upper right-hand corner of the screen.
- If the screen does not show [Home] for **F2**, push **F1** (Back), and then push **F2** to show [Home].

2. Push **F2** (Menu).

10:00 am	FWD	Rdy	Home
Freq Reference (AI)			
U1-01	Hz		0.00
Output Frequency			
U1-02	Hz		0.00
Output Current			
U1-03	A		0.00
Menu			

3. Push **▲** / **▼** to select [Initial Setup], then push **↵**.

10:00 am	FWD	Menu
User Custom Parameters		
Parameter Backup/Restore		
Modified Param / Fault Log		
Auto-Tuning		
Initial Setup		
Diagnostic Tools		
Home		

4. Push **▲** / **▼** to select [Show Initial Setup Screen], then push **↵**.

10:00 am	FWD	Init Setup
Language Selection		
Set Date/Time		
Setup Wizard		
Show Initial Setup Screen		
Back Home		

5. Push **▲** / **▼** to select [No], then push **↵**.

10:00 am	FWD	Init Setup
Show Initial Setup Screen		
No		
Yes		
Back Home		

- [No]: The keypad will not show the Initial Setup Screen when the drive is energized.
- [Yes]: The keypad will show the Initial Setup Screen when the drive is energized.

◆ Control Circuit Terminal Block Functions

Hx-xx parameters set functions for the multi-function input and output terminals.

⚠ WARNING Sudden Movement Hazard. Correctly wire and test all control circuits to make sure that the control circuits operate correctly. If you use a drive that has incorrect control circuit wiring or operation, it can cause death or serious injury.

⚠ WARNING Sudden Movement Hazard. Check the I/O signals and the external sequences for the drive before you set the Application Preset function. When you set the Application Preset function (A1-06 ≠ 0), it changes the I/O terminal functions for the drive and it can cause equipment to operate unusually. This can cause serious injury or death.

NOTICE The drive can fail if users frequently turn the drive ON and OFF with the MC on the power source side to Run and Stop the drive. Incorrect operation can decrease the service life of the relay contacts and electrolytic capacitors. If you frequently use the magnetic contactor on the power source side to Run and Stop the drive, it can cause drive failure.

Input Terminals

Refer to [Table 10.1](#) for a list of input terminals and functions.

Table 10.1 Multi-function Input Terminals

Type	Terminal	Name (Default)	Function (Signal Level)
Digital Inputs	S1	MFDI selection 1 (ON: Forward run OFF: Stop)	<ul style="list-style-type: none"> • Photocoupler • 24 V, 6 mA <p>Note: Install the wire jumpers between terminals SC-SP and SC-SN to set the MFDI power supply (sinking/sourcing mode or internal/external power supply).</p> <ul style="list-style-type: none"> • Sinking Mode: Install a jumper between terminals SC and SP. <p>NOTICE Do not close the circuit between terminals SC and SN. A closed circuit between these terminals will cause damage to the drive.</p> <ul style="list-style-type: none"> • Sourcing Mode: Install a jumper between terminals SC and SN. <p>NOTICE Do not close the circuit between terminals SC and SP. A closed circuit between these terminals will cause damage to the drive.</p> <ul style="list-style-type: none"> • External power supply: No jumper necessary between terminals SC-SN and terminals SC-SP.
	S2	MFDI selection 2 (ON: Reverse run OFF: Stop)	
	S3	MFDI selection 3 (External fault (N.O.))	
	S4	MFDI selection 4 (Fault reset)	
	S5	MFDI selection 5 (Multi-step speed reference 1)	
	S6	MFDI selection 6 (Multi-step speed reference 2)	
	S7	MFDI selection 7 (Jog command)	
	S8	MFDI selection 8 (Baseblock command (N.O.))	
	SN	MFDI power supply 0 V	
	SC	MFDI selection common	NOTICE Do not close the circuit between terminals SP and SN. A closed circuit between these terminals will cause damage to the drive.
SP	MFDI power supply +24 Vdc		
Safe Disable Input	H1	Safe Disable input 1	Remove the jumper between terminals H1-HC and H2-HC to use the Safe Disable input. <ul style="list-style-type: none"> • 24 V, 6 mA • ON: Normal operation • OFF: Coasting motor • Internal impedance 4.7 kΩ • OFF Minimum OFF time of 2 ms.
	H2	Safe Disable input 2	
	HC	Safe Disable function common	Safe Disable function common <p>NOTICE Do not close the circuit between terminals HC and SN. A closed circuit between these terminals will cause damage to the drive.</p>

10 Drive Start-Up Procedure

Type	Terminal	Name (Default)	Function (Signal Level)
Master Frequency Reference	RP	Master frequency reference pulse train input (Master frequency reference)	<ul style="list-style-type: none"> Response frequency: 0 Hz to 32 kHz H level duty: 30% to 70% H level voltage: 3.5 V to 13.2 V L level voltage: 0.0 V to 0.8 V Input impedance: 3 kΩ
	+V	Power supply for frequency setting	10.5 V (allowable current 20 mA maximum)
	-V	Power supply for frequency setting	-10.5 V (allowable current 20 mA maximum)
	A1	MFAI1 (Master frequency reference)	Voltage input or current input Select terminal A1 with DIP switch S1-1 and H3-01 [Terminal A1 Signal Level Select].
	A2	MFAI2 (Combined to terminal A1)	Select terminal A2 with DIP switch S1-2 and H3-09 [Terminal A2 Signal Level Select] <ul style="list-style-type: none"> -10 V to +10 V/-100% to +100% (input impedance: 20 kΩ) 0 V to 10 V/100% (input impedance: 20 kΩ) 4 mA to 20 mA/100%, 0 mA to 20 mA/100% (input impedance: 250 Ω)
	A3	MFAI3/PTC input (Auxiliary frequency reference)	<ul style="list-style-type: none"> Voltage input or current input Select using DIP switch S1-3 and H3-05 [Terminal A3 Signal Level Select]. -10 V to +10 V/-100% to +100% (input impedance: 20 kΩ) 0 V to 10 V/100% (input impedance: 20 kΩ) 4 mA to 20 mA/100%, 0 mA to 20 mA/100% (input impedance: 250 Ω) <p>• PTC input (Motor Overheat Protection) Set DIP switch S4 to "PTC" and set DIP switch S1-3 to "V" to set terminal A3 for PTC input.</p>
	AC	Frequency reference common	0 V
E (G)	Connecting shielded cable	-	

■ Output Terminals

Refer to [Table 10.2](#) and [Table 10.3](#) for a list of output terminals and functions.

Table 10.2 Control Circuit Output Terminals

Type	Terminal	Name (Default)	Function (Signal Level)
Fault Relay Output	MA	N.O. output (Fault)	<ul style="list-style-type: none"> Relay output 30 Vdc, 10 mA to 1 A 250 Vac, 10 mA to 1 A Minimum load: 5 V, 10 mA (Reference value)
	MB	N.C. output (Fault)	
	MC	Digital output common	
MFDO	M1	MFDO (During Run)	<ul style="list-style-type: none"> Relay output 30 Vdc, 10 mA to 1 A 250 Vac, 10 mA to 1 A Minimum load: 5 V, 10 mA (Reference value) <p>Note: Do not set functions that frequently switch ON/OFF to MFDO (M1 to M6) because this will decrease the performance life of the relay contacts. Yaskawa estimates switching life at 200,000 times (assumes 1 A, resistive load).</p>
	M2		
	M3	MFDO (Zero Speed)	
	M4		
	M5	MFDO (Speed Agree 1)	
	M6		

Table 10.3 Control Circuit Monitor Output Terminals

Type	Terminal	Name (Default)	Function (Signal Level)
Monitor Output	MP	Pulse train output (Output frequency)	32 kHz (maximum) Refer to "Pulse Train Output" on page 60 for more information.
	FM	Analog monitor output 1 (Output frequency)	Select voltage or current output. <ul style="list-style-type: none"> 0 V to 10 V/0% to 100% -10 V to +10 V/-100% to +100% 4 mA to 20 mA (receiver recommended impedance: 250 Ω)
	AM	Analog monitor output 2 (Output current)	<p>Note: Select with jumper switch S5 and H4-07 [Terminal FM Signal Level Select] or H4-08 [Terminal AM Signal Level Select].</p>
	AC	Monitor common	0 V

External Power Supply Input Terminals

Refer to [Table 10.4](#) for a list of the functions of the external power supply input terminals.

Table 10.4 External Power Supply Input Terminals

Type	Terminal	Name (Default)	Function
External Power Supply Input Terminals	PS	External 24 V power supply input	Supplies backup power to the drive control circuit, keypad, and option board. 21.6 VDC to 26.4 VDC, 700 mA
	AC	External 24 V power supply ground	0 V

Serial Communication Terminals

Refer to [Table 10.5](#) for a list of serial communication terminals and functions.

Table 10.5 Serial Communication Terminals

Type	Terminal	Terminal Name	Function (Signal Level)	
Modbus Communication	D+	Communication input/output (+)	MEMOBUS/Modbus communications Use an RS-485 cable to connect the drive. Note: Set DIP switch S2 to ON to enable the termination resistor in the last drive in a MEMOBUS/Modbus network.	<ul style="list-style-type: none"> RS-485 MEMOBUS/Modbus communication protocol Maximum 115.2 kbps
	D-	Communication output (-)		
	AC	Signal ground	0 V	

Control Circuit Terminal Configuration

The control circuit terminals are in the positions shown in [Figure 10.1](#).

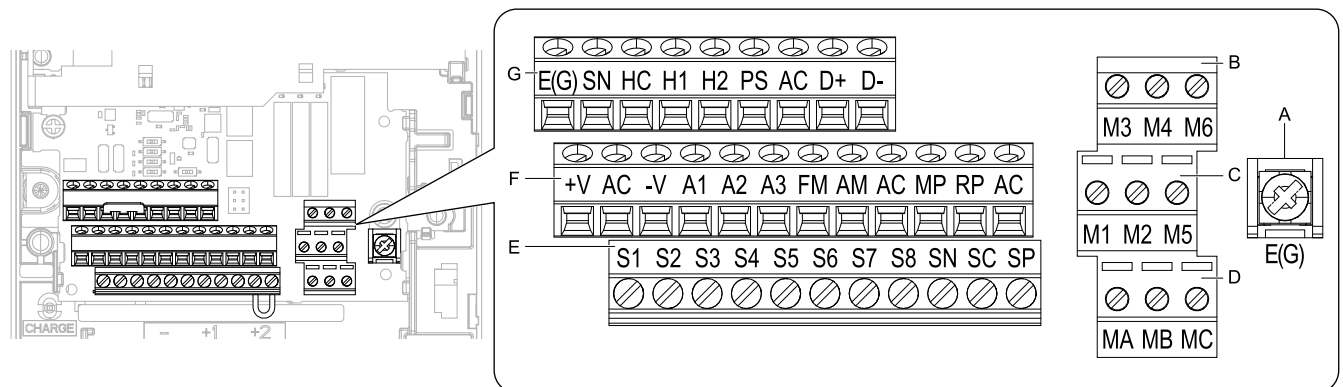

A - Terminal block (TB5)
B - Terminal block (TB2-3)
C - Terminal block (TB2-2)
D - Terminal block (TB2-1)

E - Terminal block (TB1)
F - Terminal block (TB3)
G - Terminal block (TB4)

Figure 10.1 Control Circuit Terminal Arrangement

The tightening torque for the terminal screws is shown on the reverse side or the lower front side of the front cover.

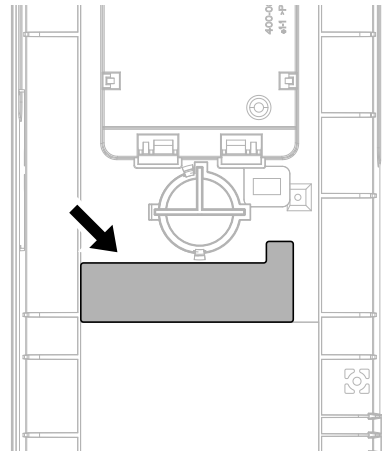

Figure 10.2 Tightening Torque Display Location (Reverse side of Front Cover)

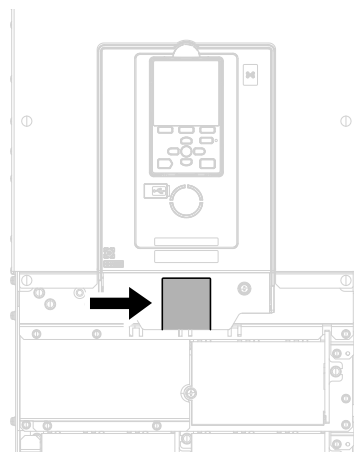

Figure 10.3 Tightening Torque Display Location (Lower Front Side of Front Cover)

■ Control Circuit Wire Gauges and Tightening Torques

Use the tables in this section to select the correct wires. Use shielded wire to wire the control circuit terminal block. Use crimp ferrules on the wire ends to make the wiring procedure easier and more reliable.

Table 10.6 Control Circuit Wire Gauges and Tightening Torques

Terminal Block	Terminal	Screw Size	Tightening Torque N·m (in·lb)	Bare Wire		Crimp Ferrule	
				Recommended Gauge mm ² (AWG)	Applicable Gauge mm ² (AWG)	Recommended Gauge mm ² (AWG)	Applicable Gauge mm ² (AWG)
TB1	S1 - S8, SN, SC, SP	M3	0.5 - 0.6 (4.4 - 5.3)	0.75 (18)	<ul style="list-style-type: none"> • Stranded wire 0.2 - 1.0 (24 - 16) • Solid wire 0.2 - 1.5 (24 - 16) 	0.5 (20)	0.25 - 0.5 (24 - 20)
TB2	M1 - M6, MA, MB, MC						
TB3	+V, AC, -V, A1, A2, A3, FM, AM, AC, MP, RP, AC						
TB4	E (G), SN, HC, H1, H2, PS, AC, D+, D-						
TB5	E (G)	M3.5	0.5 - 1.0 (4.4 - 8.9)	0.5 - 2 (20 - 14)	1.25 (12)	-	-

Crimp Ferrules

Attach an insulated sleeve when you use crimp ferrules. Refer to [Table 10.7](#) for the recommended external dimensions and model numbers of the crimp ferrules.

Use the CRIMPFOX 6, a crimping tool made by PHOENIX CONTACT.

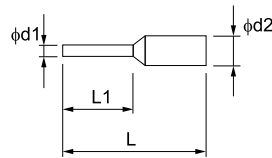

Figure 10.4 External Dimensions of Crimp Ferrules

Table 10.7 Crimp Ferrule Models and Sizes

Wire Gauge mm ² (AWG)	Model	L (mm)	L1 (mm)	φd1 (mm)	φd2 (mm)
0.25 (24)	AI 0.25-8YE	12.5	8	0.8	2.0
0.34 (22)	AI 0.34-8TQ	12.5	8	0.8	2.0
0.5 (20)	AI 0.5-8WH, AI 0.5-8OG	14	8	1.1	2.5

◆ Wiring the Control Circuit Terminal

⚠ WARNING *Electrical Shock Hazard. Do not remove covers or touch circuit boards while the drive is energized. If you touch the internal components of an energized drive, it can cause serious injury or death.*

NOTICE *Do not let wire shields touch other signal lines or equipment. Insulate the wire shields with electrical tape or shrink tubing. If you do not insulate the wire shields, it can cause a short circuit and damage the drive.*

Note:

- Isolate control circuit wiring from main circuit wiring (terminals R/L1, S/L2, T/L3, B1, B2, U/T1, V/T2, W/T3, -, +1, +2) and other high-power wiring. If the control circuit wires are adjacent to the main circuit wires, the drive or the devices around the drive may malfunction due to electrical interference.
- Isolate contact output terminals MA, MB, MC and M1-M6 from other control circuit wiring. If the output terminal wires are adjacent to other control circuit wires, the drive or devices around it may malfunction due to electrical interference.
- Connect the control circuit to a power supply of Class 2 (UL standard). Improper application of peripheral devices could result in drive performance degradation due to improper power supply.
- Connect the shield of shielded cable to the applicable ground terminal. If the grounding is not correct, the drive or devices around it may malfunction due to electrical interference.

Correctly ground the drive terminals and complete main circuit wiring before you wire the control circuit. Remove the keypad and front cover.

1. Push in on the tabs on the both sides of the LED status ring board to release the board from the bracket. Pull the board forward to remove it.

NOTICE *When you remove the LED Status Board from the drive bracket, make sure that you temporarily install it in the holding position provided on the drive. If you cause damage to the LED status ring board, the LEDs will not function correctly.*

Note:

You can temporarily store the LED status ring board with the temporary placement holes on the drive. The location of the temporary placement holes is different on different drive models.

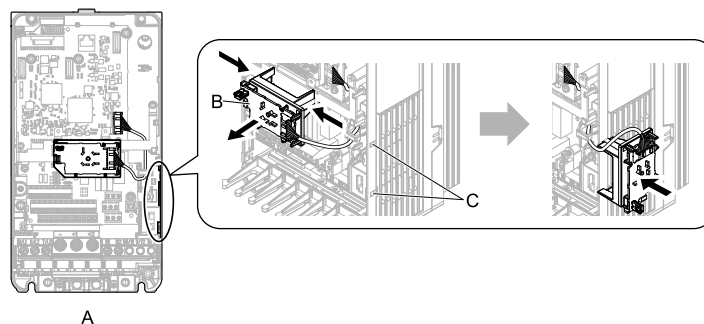

A - Drive front

B - LED status ring board

C - Temporary placement holes

Figure 10.5 Remove the LED Status Ring Board

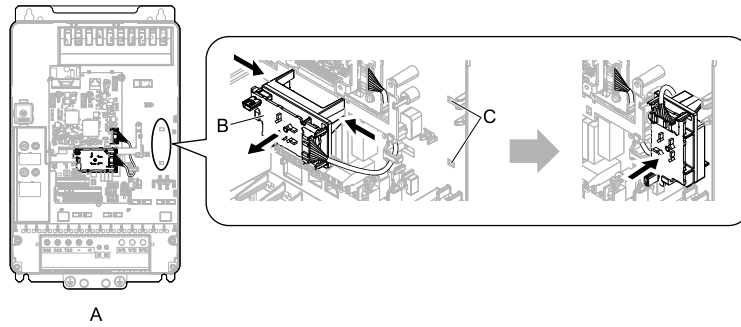

A - Drive front

B - LED status ring board

C - Temporary placement holes

Figure 10.6 Remove the LED Status Ring Board

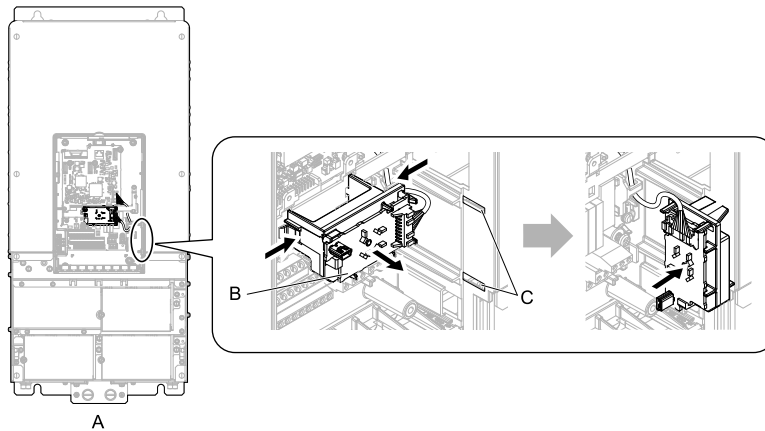

A - Drive front

B - LED status ring board

C - Temporary placement holes

Figure 10.7 Remove the LED Status Ring Board

2. Refer to the following figure and wire the control circuit.

⚠ WARNING *Fire Hazard. Tighten all terminal screws to the correct tightening torque. Connections that are too loose or too tight can cause incorrect operation and damage to the drive. Incorrect connections can also cause death or serious injury from fire.*

Note:

- To prevent malfunction due to electrical interference, use shielded wires and shielded twisted-pair wires for the control circuit terminal wiring. If the grounding is not correct, the drive or devices around it may malfunction due to electrical interference.
- Do not use control circuit wiring that is longer than 50 m (164 ft) to supply the frequency reference with an analog signal from a remote source. Failure to observe this could cause unsatisfactory system performance.

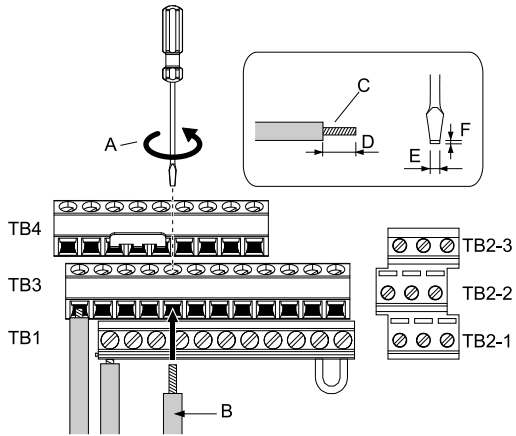

- A - Loosen the screws and put the wire into the opening on the terminal block.**
- B - Wire with a crimp ferrule attached, or unsoldered wire with the core wires lightly twisted**
- C - Pull back the shielding and lightly twist the end with your fingers to keep the ends from fraying.**
- D - Remove approximately 5.5 mm (0.21 in) of the covering at the end of the wire if you do not use crimp ferrules.**
- E - Blade width of 2.5 mm (0.1 in) or less**
- F - Blade depth of 0.4 mm (0.01 in) or less**

Figure 10.8 Wiring Procedure for the Control Circuit

Note:

- Do not solder the core wire. Soldered wire connections can become loose over time and cause unsatisfactory drive performance.
- Tighten all terminal screws to the correct tightening torque. Connections that are too loose or too tight can cause incorrect operation and damage to the drive. Incorrect connections can also cause death or serious injury from fire.
- Refer to [Figure 10.9](#) for information to prepare terminal ends of the shielded wire.
- Prepare the wire ends of shielded twisted-pair wires as shown in [Figure 10.9](#) to use an analog reference from an external frequency setting potentiometer to set the frequency. Connect the shield to terminal E (G) of the drive.

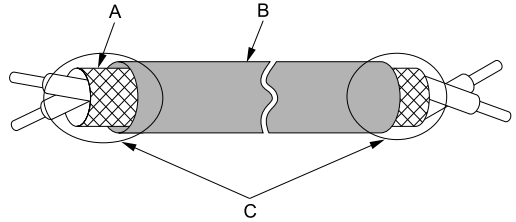

- A - Connect the shield to terminal E (G) of the drive.**
- B - Sheath**
- C - Insulate with electrical tape or shrink tubing.**

Figure 10.9 Prepare the Ends of Shielded Wire

3. Put the cable through the clearance in the wiring cover.

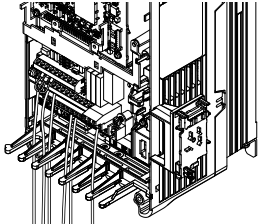

Figure 10.10 Control Circuit Wiring

4. Install the LED status ring board, front cover, and the keypad to their initial positions.

◆ Switches and Jumpers on the Terminal Board

The terminal board has switches to adapt the drive I/Os to the external control signals as shown in Figure 10.11. Set the switches to select the functions for each terminal.

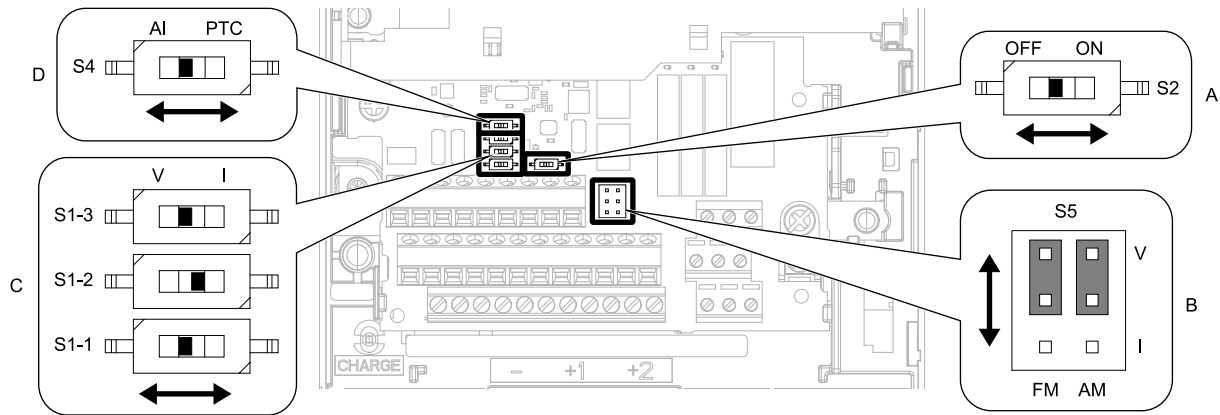

Figure 10.11 Locations of Switches

Table 10.8 I/O Terminals and Switches Functions

Position	Switch	Terminal	Function	Default Setting
A	DIP switch S2	-	Enables and disables the MEMOBUS/Modbus communications termination resistor.	OFF
B	Jumper switch S5	FM, AM	Sets terminals FM and AM to voltage or current output.	FM: V (voltage output) AM: V (voltage output)
C	DIP switch S1-1	A1	Selects the input signal type (voltage/current).	V (voltage input)
	DIP switch S1-2	A2	Selects the input signal type (voltage/current).	I (current input)
	DIP switch S1-3	A3	Selects the input signal type (voltage/current).	V (voltage input)
D	Dip switch S4	A3	Selects MFAI or PTC input.	AI (analog input)

◆ Control I/O Connections

This section gives information about the settings for the listed control circuit I/O signals.

- MFDI (terminals S1 to S8)
- Pulse train output (terminal MP)
- MFAI (terminals A1 to A3)
- PTC input (terminal A3)
- MFAO (terminals FM, AM)
- MEMOBUS/Modbus communications (terminals D+, D-, AC)

■ Pulse Train Output

You can use pulse train monitor output terminal MP for sourcing mode or for sinking mode.

- Use for sourcing mode
The load impedance changes the voltage level of the pulse train output signal.

Load Impedance $R_L(k\Omega)$	Output Voltage $V_{MP}(V)$
1.5 k Ω or more	5 V or more
4.0 k Ω or more	8 V or more
10 k Ω or more	10 V or more

Note:

Use the formula in Figure 10.12 to calculate the necessary load resistance (k Ω) to increase output voltage $V_{MP}(V)$.

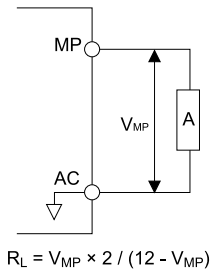

A - Load Impedance

Figure 10.12 Wiring to Use Pulse Train Output in Sourcing Mode

- Use in sinking mode
The external power supply changes the voltage level of the pulse train output signal. Keep the voltage from an external source between 10.8 Vdc to 16.5 Vdc. Adjust the load impedance to keep the current at 16 mA or lower.

External Power Supply (V)	Load Impedance (kΩ)	Sinking current (mA)
10.8 Vdc to 16.5 Vdc	1.0 kΩ or more	16 mA maximum

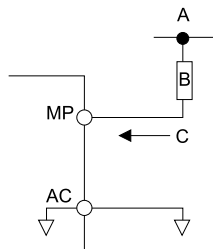

- A - External power supply**
- B - Load Impedance**
- C - Sinking current**

Figure 10.13 Wiring to Use Pulse Train Output in Sinking Mode

■ Set Sinking Mode/Sourcing Mode

Close the circuit between terminals SC-SP and SC-SN to set the sinking mode/sourcing mode and the internal/external power supply for the MFDI terminals. The default setting for the drive is internal power supply sinking mode.

NOTICE Do not close the circuit between terminals SP and SN. A closed circuit between these terminals will cause damage to the drive.

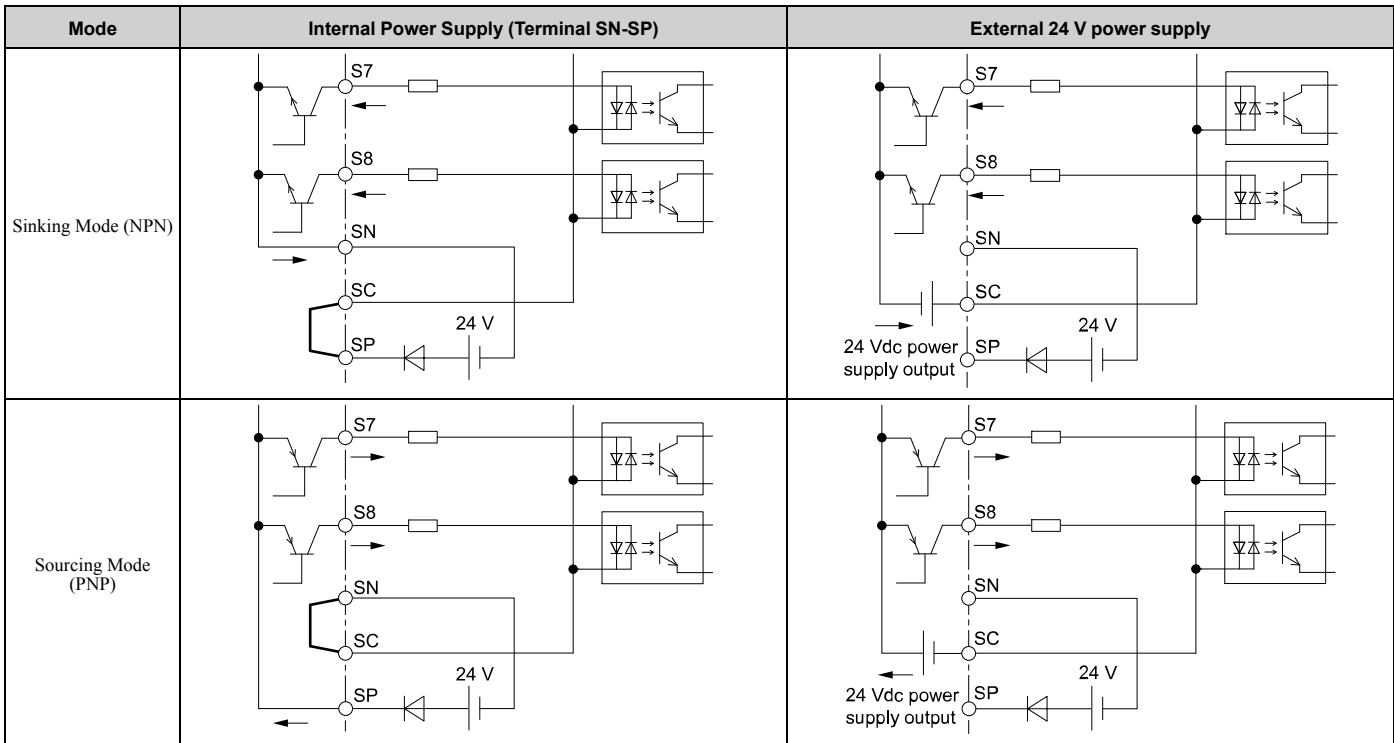

■ Set Input Signals for MFAI Terminals A1 to A3

Use terminals A1 to A3 to input a voltage or a current signal. Set the signal type as shown in [Table 10.9](#).

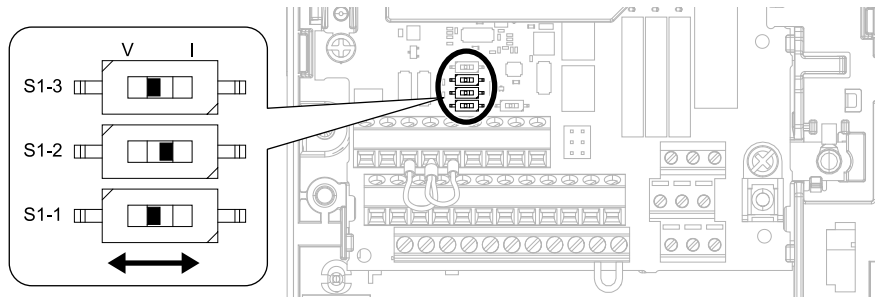

Figure 10.14 Location of DIP Switch S1

Table 10.9 MFAI Terminals A1 to A3 Signal Settings

Terminal	Input Signal	DIP Switch Settings		Parameter	
		Switch	Setting	No.	Signal Level
A1	Voltage input	S1-1	V (Default)	H3-01	0: 0 V to 10 V/0% to 100% (input impedance: 20 kΩ) 1: -10 V to +10 V/-100% to 100% (input impedance: 20 kΩ)
	Current input		I		2: 4 mA to 20 mA/0% to 100% (input impedance: 250 Ω) 3: 0 mA to 20 mA/0% to 100% (input impedance: 250 Ω)
A2	Voltage input	S1-2	V	H3-09	0: 0 V to 10 V/0% to 100% (input impedance: 20 kΩ) 1: -10 V to +10 V/-100% to 100% (input impedance: 20 kΩ)
	Current input		I (Default)		2: 4 mA to 20 mA/0% to 100% (input impedance: 250 Ω) 3: 0 mA to 20 mA/0% to 100% (input impedance: 250 Ω)
A3	Voltage input	S1-3	V (Default)	H3-05	0: 0 V to 10 V/0% to 100% (input impedance: 20 kΩ) 1: -10 V to +10 V/-100% to 100% (input impedance: 20 kΩ)
	Current input		I		2: 4 mA to 20 mA/0% to 100% (input impedance: 250 Ω) 3: 0 mA to 20 mA/0% to 100% (input impedance: 250 Ω)

Note:

- Set $H3-02, H3-10 = 0$ [Terminal A1 Function Selection, Terminal A2 Function Selection = Frequency Reference] to set A1 and A2 to frequency reference. The drive will add the analog input values together to make the frequency reference.
- Use tweezers or a jig with a tip width of approximately 0.8 mm (0.03 in) to set DIP switches.
- Set DIP switch S4 to “AI” to use terminal A3 as an analog input (voltage/current) terminal. The default setting for DIP switch S4 is “AI”.

■ **Set MFAI Terminal A3 to PTC Input**

Set terminal A3 as an MFAI or as the PTC input for motor overload protection.

Use DIP switch S4 to set the input function.

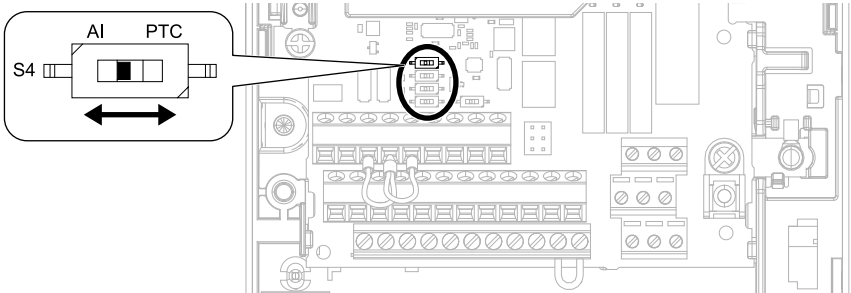

Figure 10.15 Location of DIP Switch S4

Terminal	Settings for DIP Switches	Description
A3	AI (Default)	Functions as an MFAI terminal. Set $H3-06$ [Terminal A3 Function Selection] to select the input function.
	PTC	Functions as the PTC input terminal. Set $H3-06 = E$ [Motor Temperature (PTC Input)]. Set S1-3 to “V” for voltage input.

■ **Set Output Signals for MFAO Terminals FM, AM**

Set the signal type for terminals AM and FM to voltage or current output. Use jumper switch S5 and $H4-07, H4-08$ [Terminal FM Signal Level Select, Terminal AM Signal Level Select] to set the signal type.

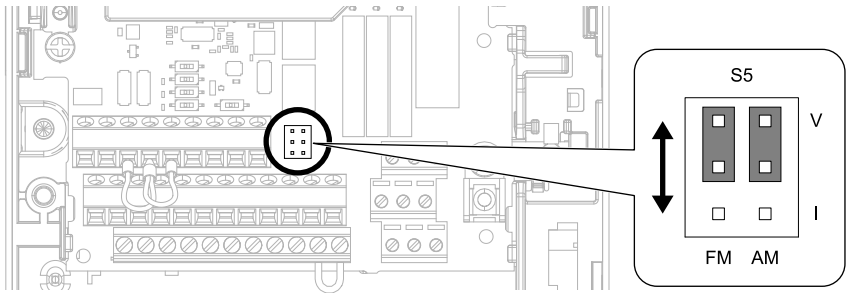





Figure 10.16 Location of Jumper Switch S5

Terminal	Types of Output Signals	Jumper Switch S5	Parameter	
			No.	Signal Level
FM	Voltage output (Default)		H4-07	0: 0 V to 10 V 1: -10 V to +10 V
	Current output			2: 4 mA to 20 mA
AM	Voltage output (Default)		H4-08	0: 0 V to 10 V 1: -10 V to +10 V
	Current output			2: 4 mA to 20 mA

■ Switch ON Termination Resistor for MEMOBUS/Modbus Communications

When the drive is the last slave in a MEMOBUS/Modbus communications, set DIP switch S2 to the ON position. This drive has a built-in termination resistor for the RS-485 interface.

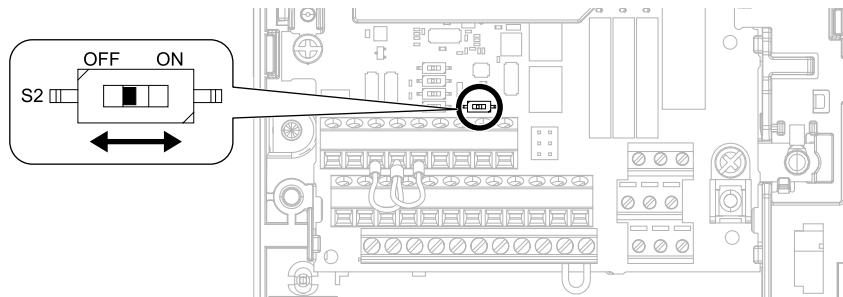

Figure 10.17 Location of DIP Switch S2

Table 10.10 MEMOBUS/Modbus Communications Termination Resistor Setting

DIP Switch S2	Description
ON	The built-in termination resistor is ON.
OFF (Default)	The built-in termination resistor is OFF.

11 Drive Control, Duty Modes, and Programming

◆ Selecting the Control Method

This section gives information about these basic control methods:

- V/f Control
- Open Loop Vector Control (OLV)
- EZ Open Loop Vector Control (EZOLV) for induction motors only

Refer to the Technical Manual for information about speed feedback and Permanent Magnet/Synchronous Reluctance motor control methods.

Use *A1-02 [Control Method Selection]* to select the most applicable control method for your application.

Control Method	A1-02 Setting	Main Applications
V/f	0	<ul style="list-style-type: none"> General variable-speed, best to operate more than one motor from one drive. When motor parameters are not available.
OLV	2 (Default)	<ul style="list-style-type: none"> General variable-speed High precision and high speed response without speed feedback
EZOLV	8	<ul style="list-style-type: none"> General variable-speed No high precision, no high speed response, and no speed feedback

◆ Drive Duty Modes

The drive has two duty modes from which to select for the application: Heavy Duty (HD) and Normal Duty (ND).

- The input power kVA
- The maximum applicable motor output
- The rated input current
- The rated output capacity
- The rated output current

Note:

The reference for the parameter set as a percentage of the drive rated output current is the rated output current of HD/ND.

Refer to [Table 11.1](#) for information about the differences between HD and ND ratings.

Table 11.1 Drive Duty Modes

Duty Rating	C6-01 Setting	Application	Default Carrier Frequency	Overload Tolerance (oL2 [Drive Overload])
Heavy Duty Rating (HD)	0	<ul style="list-style-type: none"> Extruder Conveyor Constant torque or high overload capacity 	2 kHz	150% of the rated output current for 60 seconds The permitted frequency of overload is one time each 10 minutes.
Normal Duty Rating (ND)	1	<ul style="list-style-type: none"> Fan Pump Blower Variable speed control 	2 kHz Swing-PWM	110% of the rated output current for 60 seconds The permitted frequency of overload is one time each 10 minutes.

◆ Auto-Tuning

⚠ WARNING *Crush Hazard. This seems incorrect. The drive should not take a 60 Hz motor to 90 Hz during tuning. We think this is a translation error. Please confirm it. Increased motor frequency can cause serious injury or death.*

⚠ WARNING *Before you do Rotational Auto-Tuning, disconnect the load from the motor. The load can move suddenly and cause serious injury or death.*

Auto-Tuning automatically sets parameters on the drive connected to the motor. You must input some parameters individually during Auto-Tuning.

1. Select [Auto-Tuning] from the main menu to select the Auto-Tuning Mode.
2. Use the information in [Table 11.2](#) and [Table 11.3](#) to set *T1-01 [Auto-Tuning Mode Selection]* and *T4-01 [EZ Tuning Mode Selection]*.
3. Push  to start Auto-Tuning.
Refer to the Technical Manual for more information about Auto-Tuning.









Table 11.2 Auto-Tuning Mode Selection

Type	T1-01	Application Conditions and Benefits	A1-02 [Control Method Selection]	
			0 [V/f]	2 [OLV]
Rotational Auto-Tuning	0	Recommended tuning mode for the most accurate results. Select this tuning mode when: <ul style="list-style-type: none"> You can decouple the motor from the load. You cannot decouple the motor from the load, but the motor load is less than 30%. 	-	Yes
Stationary Auto-Tuning ¹	1	Automatically calculates motor parameters for vector control. Select this tuning mode when: <ul style="list-style-type: none"> You cannot decouple the motor from the load. The motor test report data is not available. 	-	Yes
Stationary Line-Line Resistance	2	Select this tuning mode when: <ul style="list-style-type: none"> The drive and motor capacities are different. The drive is in V/f Control. You have replaced the drive and motor. 	Yes	Yes

Table 11.3 EZ Tuning Mode Selection

Type	T4-01	Application Conditions and Benefits	A1-02 = 8 [EZOLV]
Motor Parameter Setting	0	Set the motor parameters.	Yes
Line-to-Line Resistance	1	Select this tuning mode after you replace the drive, motor, and motor cables.	Yes

◆ Drive Parameters

Icon	Description
	The parameter is available when operating the drive with V/f Control.
	The parameter is available when operating the drive with Closed Loop V/f Control.
	The parameter is available when operating the drive with Open Loop Vector Control.
	The parameter is available when operating the drive with Closed Loop Vector Control.
	The parameter is available when operating the drive with Advanced Open Loop Vector Control.
	The parameter is available when operating the drive with Open Loop Vector Control for PM.
	The parameter is available when operating the drive with Advanced Open Loop Vector Control for PM.
	The parameter is available when operating the drive with Closed Loop Vector Control for PM.
	The parameter is available when operating the drive with EZ Open Loop Vector Control.
RUN	The parameter can be changed settings during run.

Note:

Gray icons identify parameters that are not available in the specified control method.

Refer to the following table when setting the most important parameters.

No. (Hex.)	Name	Description
A1-00 (0100) RUN	Language Selection	<p>V/f CL-V/f OLV CLV AOLV OLV/IPM AOLV/IPM CLV/IPM EZOLV</p> <p>Sets the language for the LCD keypad.</p> <p>0 : English 1 : Japanese 2 : German 3 : French 4 : Italian 5 : Spanish 6 : Portuguese 7 : Chinese 8 : Czech 9 : Russian 10 : Turkish 11 : Polish 12 : Greek</p>
A1-02 (0102)	Control Method Selection	<p>V/f CL-V/f OLV CLV AOLV OLV/IPM AOLV/IPM CLV/IPM EZOLV</p> <p>Sets the control method for the drive application and the motor.</p> <p>0 : V/f Control 1 : V/f Control with Encoder 2 : Open Loop Vector 3 : Closed Loop Vector 4 : Advanced Open Loop Vector 5 : PM Open Loop Vector 6 : PM Advanced Open Loop Vector 7 : PM Closed Loop Vector 8 : EZ Vector Control</p>
A1-03 (0103)	Initialize Parameters	<p>V/f CL-V/f OLV CLV AOLV OLV/IPM AOLV/IPM CLV/IPM EZOLV</p> <p>Sets parameters to default values.</p> <p>0 : No Initialization 1110 : User Initialization 2220 : 2-Wire Initialization 3330 : 3-Wire Initialization</p>
b1-01 (0180)	Frequency Reference Selection 1	<p>V/f CL-V/f OLV CLV AOLV OLV/IPM AOLV/IPM CLV/IPM EZOLV</p> <p>Sets the input method for the frequency reference.</p> <p>0 : Keypad 1 : Analog Input 2 : Memobus/Modbus Communications 3 : Option PCB 4 : Pulse Train Input</p>
b1-02 (0181)	Run Command Selection 1	<p>V/f CL-V/f OLV CLV AOLV OLV/IPM AOLV/IPM CLV/IPM EZOLV</p> <p>Sets the input method for the Run command.</p> <p>0 : Keypad 1 : Digital Input 2 : Memobus/Modbus Communications 3 : Option PCB</p>
b1-03 (0182)	Stopping Method Selection	<p>V/f CL-V/f OLV CLV AOLV OLV/IPM AOLV/IPM CLV/IPM EZOLV</p> <p>Sets the method to stop the motor after removing a Run command or entering a Stop command.</p> <p>0 : Ramp to Stop 1 : Coast to Stop 2 : DC Injection Braking to Stop 3 : Coast to Stop with Timer</p>
b1-04 (0183)	Reverse Operation Selection	<p>V/f CL-V/f OLV CLV AOLV OLV/IPM AOLV/IPM CLV/IPM EZOLV</p> <p>Sets the reverse operation function. Disable reverse operation in fan or pump applications where reverse rotation is dangerous.</p> <p>0 : Reverse Enabled 1 : Reverse Disabled</p>
C1-01 (0200) RUN	Acceleration Time 1	<p>V/f CL-V/f OLV CLV AOLV OLV/IPM AOLV/IPM CLV/IPM EZOLV</p> <p>Sets the length of time to accelerate from zero to maximum output frequency.</p>
C1-02 (0201) RUN	Deceleration Time 1	<p>V/f CL-V/f OLV CLV AOLV OLV/IPM AOLV/IPM CLV/IPM EZOLV</p> <p>Sets the length of time to decelerate from maximum output frequency to zero.</p>

11 Drive Control, Duty Modes, and Programming

No. (Hex.)	Name	Description
C2-01 (020B)	S-Curve Time @ Start of Accel	V/f CL-V/f OLV CLV AOLV OLV/PM AOLV/PM CLV/PM EZOLV Sets the S-curve acceleration time at start.
C2-02 (020C)	S-Curve Time @ End of Accel	V/f CL-V/f OLV CLV AOLV OLV/PM AOLV/PM CLV/PM EZOLV Sets the S-curve acceleration time at completion.
C2-03 (020D)	S-Curve Time @ Start of Decel	V/f CL-V/f OLV CLV AOLV OLV/PM AOLV/PM CLV/PM EZOLV Sets the S-curve deceleration time at start.
C2-04 (020E)	S-Curve Time @ End of Decel	V/f CL-V/f OLV CLV AOLV OLV/PM AOLV/PM CLV/PM EZOLV Sets the S-curve deceleration time at completion.
C6-01 (0223)	Normal / Heavy Duty Selection	V/f CL-V/f OLV CLV AOLV OLV/PM AOLV/PM CLV/PM EZOLV Sets the drive duty rating. 0 : Heavy Duty Rating 1 : Normal Duty Rating
C6-02 (0224)	Carrier Frequency Selection	V/f CL-V/f OLV CLV AOLV OLV/PM AOLV/PM CLV/PM EZOLV Sets the carrier frequency for the transistors in the drive. 1 : 2.0 kHz 2 : 5.0 kHz (4.0 kHz AOLV/PM) 3 : 8.0 kHz (6.0 kHz AOLV/PM) 4 : 10.0 kHz (8.0 kHz AOLV/PM) 5 : 12.5 kHz (10.0 kHz AOLV/PM) 6 : 15.0 kHz (12.0 kHz AOLV/PM) 7 : Swing PWM1 (Audible Sound 1) 8 : Swing PWM2 (Audible Sound 2) 9 : Swing PWM3 (Audible Sound 3) A : Swing PWM4 (Audible Sound 4) F : User Defined (C6-03 to C6-05)
d1-01 to d1-16 (0280 - 0291) RUN	Reference 1 to 16	V/f CL-V/f OLV CLV AOLV OLV/PM AOLV/PM CLV/PM EZOLV Sets the frequency reference in the units from <i>o1-03</i> [Frequency Display Unit Selection].
d1-17 (0292) RUN	Jog Reference	V/f CL-V/f OLV CLV AOLV OLV/PM AOLV/PM CLV/PM EZOLV Sets the Jog frequency reference in the units from <i>o1-03</i> [Frequency Display Unit Selection]. Set <i>H1-xx</i> = 6 [MFDI Function Select = Jog Reference Selection] to use the Jog frequency reference.
d2-01 (0289)	Frequency Reference Upper Limit	V/f CL-V/f OLV CLV AOLV OLV/PM AOLV/PM CLV/PM EZOLV Sets maximum limit for all frequency references. The maximum output frequency is 100%.
d2-02 (028A)	Frequency Reference Lower Limit	V/f CL-V/f OLV CLV AOLV OLV/PM AOLV/PM CLV/PM EZOLV Sets minimum limit for all frequency references. The maximum output frequency is 100%.
E1-01 (0300)	Input AC Supply Voltage	V/f CL-V/f OLV CLV AOLV OLV/PM AOLV/PM CLV/PM EZOLV Sets the drive input voltage.
E1-04 (0303)	Maximum Output Frequency	V/f CL-V/f OLV CLV AOLV OLV/PM AOLV/PM CLV/PM EZOLV Sets the maximum output frequency for the V/f pattern.
E1-05 (0304)	Maximum Output Voltage	V/f CL-V/f OLV CLV AOLV OLV/PM AOLV/PM CLV/PM EZOLV Sets the maximum output voltage for the V/f pattern.
E1-06 (0305)	Base Frequency	V/f CL-V/f OLV CLV AOLV OLV/PM AOLV/PM CLV/PM EZOLV Sets the base frequency for the V/f pattern.
E1-09 (0308)	Minimum Output Frequency	V/f CL-V/f OLV CLV AOLV OLV/PM AOLV/PM CLV/PM EZOLV Sets the minimum output frequency for the V/f pattern.
E2-01 (030E)	Motor Rated Current (FLA)	V/f CL-V/f OLV CLV AOLV OLV/PM AOLV/PM CLV/PM EZOLV Sets the motor rated current in amps.
E2-11 (0318)	Motor Rated Power	V/f CL-V/f OLV CLV AOLV OLV/PM AOLV/PM CLV/PM EZOLV Sets the motor rated output in the units from <i>o1-58</i> [Motor Power Unit Selection].
H1-01 - H1-08 (0438, 0439, 0400 - 0405)	Terminal S1 to S8 Function Selection	V/f CL-V/f OLV CLV AOLV OLV/PM AOLV/PM CLV/PM EZOLV Sets the functions for MFDI terminals S1 to S8.
H2-01 (040B)	Term M1-M2 Function Selection	V/f CL-V/f OLV CLV AOLV OLV/PM AOLV/PM CLV/PM EZOLV Sets the function for MFDO terminal M1-M2.
H2-02 (040C)	Term M3-M4 Function Selection	V/f CL-V/f OLV CLV AOLV OLV/PM AOLV/PM CLV/PM EZOLV Sets the function for MFDO terminal M3-M4.

No. (Hex.)	Name	Description
H2-03 (040D)	Term M5-M6 Function Selection	V/f CL-V/f OLV CLV AOLV OLV/PM AOLV/PM CLV/PM EZOLV Sets the function for MFDO terminal M5-M6.
H3-01 (0410)	Terminal A1 Signal Level Select	V/f CL-V/f OLV CLV AOLV OLV/PM AOLV/PM CLV/PM EZOLV Sets the input signal level for MFAI terminal A1. 0 : 0 to 10V (Lower Limit at 0) 1 : -10 to +10V (Bipolar Reference) 2 : 4 to 20 mA 3 : 0 to 20 mA
H3-02 (0434)	Terminal A1 Function Selection	V/f CL-V/f OLV CLV AOLV OLV/PM AOLV/PM CLV/PM EZOLV Sets the function for MFAI terminal A1.
H3-03 (0411) RUN	Terminal A1 Gain Setting	V/f CL-V/f OLV CLV AOLV OLV/PM AOLV/PM CLV/PM EZOLV Sets the gain of the analog signal input to MFAI terminal A1.
H3-04 (0412) RUN	Terminal A1 Bias Setting	V/f CL-V/f OLV CLV AOLV OLV/PM AOLV/PM CLV/PM EZOLV Sets the bias of the analog signal input to MFAI terminal A1.
H3-05 (0413)	Terminal A3 Signal Level Select	V/f CL-V/f OLV CLV AOLV OLV/PM AOLV/PM CLV/PM EZOLV Sets the input signal level for MFAI terminal A3. 0 : 0 to 10V (Lower Limit at 0) 1 : -10 to +10V (Bipolar Reference) 2 : 4 to 20 mA 3 : 0 to 20 mA
H3-06 (0414)	Terminal A3 Function Selection	V/f CL-V/f OLV CLV AOLV OLV/PM AOLV/PM CLV/PM EZOLV Sets the function for MFAI terminal A3.
H3-07 (0415) RUN	Terminal A3 Gain Setting	V/f CL-V/f OLV CLV AOLV OLV/PM AOLV/PM CLV/PM EZOLV Sets the gain of the analog signal input to MFAI terminal A3.
H3-08 (0416) RUN	Terminal A3 Bias Setting	V/f CL-V/f OLV CLV AOLV OLV/PM AOLV/PM CLV/PM EZOLV Sets the bias of the analog signal input to MFAI terminal A3.
H3-09 (0417)	Terminal A2 Signal Level Select	V/f CL-V/f OLV CLV AOLV OLV/PM AOLV/PM CLV/PM EZOLV Sets the input signal level for MFAI terminal A2. 0 : 0-10V (LowLim=0) 1 : -10 to +10V (Bipolar Reference) 2 : 4 to 20 mA 3 : 0 to 20 mA
H3-10 (0418)	Terminal A2 Function Selection	V/f CL-V/f OLV CLV AOLV OLV/PM AOLV/PM CLV/PM EZOLV Sets the function for MFAI terminal A2.
H3-11 (0419) RUN	Terminal A2 Gain Setting	V/f CL-V/f OLV CLV AOLV OLV/PM AOLV/PM CLV/PM EZOLV Sets the gain of the analog signal input to MFAI terminal A2.
H3-12 (041A) RUN	Terminal A2 Bias Setting	V/f CL-V/f OLV CLV AOLV OLV/PM AOLV/PM CLV/PM EZOLV Sets the bias of the analog signal input to MFAI terminal A2.
H3-13 (041B)	Analog Input FilterTime Constant	V/f CL-V/f OLV CLV AOLV OLV/PM AOLV/PM CLV/PM EZOLV Sets the time constant for primary delay filters on MFAI terminals.
H3-14 (041C)	Analog Input Terminal Enable Sel	V/f CL-V/f OLV CLV AOLV OLV/PM AOLV/PM CLV/PM EZOLV Sets the enabled terminal or terminals when $H1-xx = C$ [MFDI Function Select = Analog Terminal Enable Selection] is ON. 1 : Terminal A1 only 2 : Terminal A2 only 3 : Terminals A1 and A2 4 : Terminal A3 only 5 : Terminals A1 and A3 6 : Terminals A2 and A3 7 : Terminals A1, A2, and A3
H4-01 (041D)	Terminal FM Analog Output Select	V/f CL-V/f OLV CLV AOLV OLV/PM AOLV/PM CLV/PM EZOLV Sets the monitor number to send from MFAO terminal FM.

No. (Hex.)	Name	Description
H4-02 (041E) RUN	Terminal FM Analog Output Gain	V/f CL-V/f OLV CLV AOLV OLV/PM AOLV/PM CLV/PM EZOLV Sets the gain of the monitor signal that is sent from MFAO terminal FM.
H4-03 (041F) RUN	Terminal FM Analog Output Bias	V/f CL-V/f OLV CLV AOLV OLV/PM AOLV/PM CLV/PM EZOLV Sets the bias of the monitor signal that is sent from MFAO terminal FM.
H4-04 (0420)	Terminal AM Analog Output Select	V/f CL-V/f OLV CLV AOLV OLV/PM AOLV/PM CLV/PM EZOLV Sets the monitoring number to be output from the MFAO terminal AM.
H4-05 (0421) RUN	Terminal AM Analog Output Gain	V/f CL-V/f OLV CLV AOLV OLV/PM AOLV/PM CLV/PM EZOLV Sets the gain of the monitor signal that is sent from MFAO terminal AM.
H4-06 (0422) RUN	Terminal AM Analog Output Bias	V/f CL-V/f OLV CLV AOLV OLV/PM AOLV/PM CLV/PM EZOLV Sets the bias of the monitor signal that is sent from MFAO terminal AM.
H4-07 (0423)	Terminal FM Signal Level Select	V/f CL-V/f OLV CLV AOLV OLV/PM AOLV/PM CLV/PM EZOLV Sets the MFAO terminal FM output signal level. 0 : 0 to 10 Vdc 1 : -10 to +10 Vdc 2 : 4 to 20 mA
H4-08 (0424)	Terminal AM Signal Level Select	V/f CL-V/f OLV CLV AOLV OLV/PM AOLV/PM CLV/PM EZOLV Sets the MFAO terminal AM output signal level. 0 : 0 to 10 Vdc 1 : -10 to +10 Vdc 2 : 4 to 20 mA
L1-01 (0480)	Motor Overload (oL1) Protection	V/f CL-V/f OLV CLV AOLV OLV/PM AOLV/PM CLV/PM EZOLV Sets the motor overload protection with electronic thermal protectors. 0 : Disabled 1 : Variable Torque 2 : Constant Torque 10:1 Speed Range 3 : Constant Torque 100:1 SpeedRange 4 : PM Variable Torque 5 : PM Constant Torque 6 : Variable Torque (50Hz)
L1-02 (0481)	Motor Overload Protection Time	V/f CL-V/f OLV CLV AOLV OLV/PM AOLV/PM CLV/PM EZOLV Sets the operation time for the electronic thermal protector of the drive to prevent damage to the motor. Usually it is not necessary to change this setting.
L3-04 (0492)	Stall Prevention during Decel	V/f CL-V/f OLV CLV AOLV OLV/PM AOLV/PM CLV/PM EZOLV Sets the method that the drive will use to prevent overvoltage faults when decelerating. 0 : No 1 : General Purpose 2 : Intelligent (Ignore Decel Ramp) 3 : General Purpose w/ DB resistor 4 : Overexcitation/High Flux 5 : Overexcitation/High Flux 2
o1-58 (3125)	Motor Power Unit Selection	V/f CL-V/f OLV CLV AOLV OLV/PM AOLV/PM CLV/PM EZOLV Sets the setting unit for parameters that set the motor rated power. 0 : kW 1 : HP

12 UL Standards



Figure 12.1 UL/cUL Mark

The UL/cUL Mark indicates that this product satisfies stringent safety standards. This mark appears on products in the United States and Canada. It shows UL approval, indicating that it has been determined that the product complies with safety standards after undergoing strict inspection and assessment. UL-approved parts must be used for all major components that are built into electrical appliances that obtain UL approval.

This product has been tested in accordance with UL standard UL508C, and has been verified to be in compliance with UL standards.

Machines and devices integrated with this product must satisfy the following conditions for compliance with UL standards.

◆ Area of Use

Install this product in a location with Overvoltage Category III and pollution degree 2 or less as specified in UL508C.

■ Ambient Temperature Setting

Maintain the ambient temperature within the following ranges according to the enclosure type.

- Enclosed wall-mounted type (UL Type 1): -10 °C to +40 °C (14 °F to 104 °F)
- Open chassis type (IP20): -10 °C to +50 °C (14 °F to 122 °F)

◆ Main Circuit Wire Gauges and Tightening Torques

Refer to *Three-Phase 200 V Class on page 27* and *Three-Phase 400 V Class on page 31* for the recommended wire gauges and tightening torques of the main circuit terminals.

Comply with local standards for correct wire gauges in the region where the drive is used.

▲ WARNING *Electrical Shock Hazard. Only connect factory-recommended devices or circuits to drive terminals B1, B2, -, +1, +2, and +3 terminals. Do not connect AC power to these terminals. Incorrect wiring can cause damage to the drive and serious injury or death from fire.*

Note:

- The recommended wire gauges are based on drive continuous current ratings with 75 °C (167 °F) 600 V class 2 heat-resistant indoor PVC wire. Assume these conditions:
 - Ambient temperature: 40 °C (104 °F) or lower
 - Wiring distance: 100 m (328 ft) or shorter
 - Normal Duty Rated current value
- Refer to the instruction manual for each device for recommended wire gauges to connect peripheral devices or options to terminals +1, +2, +3, -, B1, and B2. Contact Yaskawa or your nearest sales representative if the recommended wire gauges for the peripheral devices or options are out of the range of the applicable gauges for the drive.
- 2257 to 2415 and 4208 to 4720, use UL-approved closed-loop crimp terminals on the drive main circuit terminals. Use the tools recommend by the terminal manufacturer and make sure that the terminals are correctly connected.

◆ Closed-Loop Crimp Terminals

To comply with UL standards on drive models 2257 to 2415 and 4208 to 4720, use UL-approved closed-loop crimp terminals. Use the tools recommend by the terminal manufacturer to crimp the closed-loop crimp terminal. Yaskawa recommends closed-loop crimp terminals from PANDUIT Corp. and insulation tubes.

Comply with local standards for correct wire gauges in the region where the drive is used.

Use the tools recommended by PANDUIT Corp. to crimp the closed-loop terminals.

Contact Yaskawa or your nearest sales representative to order.

Refer to [Table 12.1](#) to select crimp terminals as specified by drive model and wire gauge.

Note:

To comply with UL standards, use only insulated crimp terminals or crimp terminals with insulation tubing. Use UL-Listed, vinyl-coated insulated copper wires for operation with a continuous maximum permitted temperature of 75 °C at 600 V.

Table 12.1 Closed-Loop Crimp Terminals (Manufacturer: PANDUIT Corp.)

Model	Recommended Gauge (AWG, kcmil)					Crimp Terminal Part Number
	R/L1 S/L2 T/L3	U/T1 V/T2 W/T3	-, +1	+3	⊕	
2004 - 2021	-	-	-	-	10	P10-8R-L
2030, 2042	-	-	-	-	8	P8-10R-Q S8-10R-Q
2056	-	-	-	-	6	P6-14R-E S6-10R-E
2070 - 2110	-	-	-	-	6	P6-14R-E S6-10R-E
2138	-	-	-	-	4	P4-14R-E S4-56R-E
2169, 2211	-	-	-	-	4	P4-56R-E S4-56R-E
2257	-	-	-	-	3	S2-38R-X
	-	-	-	1/0 × 2P	-	S1/0-38R-X
	2/0 × 2P	2/0 × 2P	-	-	-	S2/0-38R-X
	-	-	4/0 × 2P	-	-	S4/0-38R-5
2313	-	-	-	-	2	S2-38R-X
	-	-	-	1/0 × 2P	-	S1/0-38R-X
	-	3/0 × 2P	-	-	-	S3/0-38R-5
	4/0 × 2P	-	-	-	-	S4/0-38R-5
	-	-	250 × 2P	-	-	S250-38R-5
2360	-	-	-	-	1	S2-12R-X
	-	-	-	3/0 × 2P	-	S3/0-12R-5
	250 × 2P	250 × 2P	-	-	-	S250-12R-5
	-	-	350 × 2P	-	-	LCA350-12-X LCAX350-12-6
2415	-	-	-	-	1	S2-12R-X
	-	-	-	3/0 × 2P	-	S3/0-12R-5
	250 × 2P	-	-	-	-	S250-12R-5
	-	300 × 2P	-	-	-	LCA300-12-X LCAX300-12-6
	-	-	350 × 2P	-	-	LCA350-12-X LCAX350-12-6
4002, 4004	-	-	-	-	12	P10-8R-L
4005 - 4012	-	-	-	-	10	P10-8R-L
4018, 4023	-	-	-	-	10	P10-10R-L
4031	-	-	-	-	8	P8-14R-Q S8-14R-Q
4038	-	-	-	-	6	P6-14R-E S6-14R-E
4044, 4060	-	-	-	-	6	P6-14R-E S6-14R-E
4075	-	-	-	-	6	P6-14R-E S6-14R-E
4089, 4103	-	-	-	-	4	P4-14R-E S4-14R-E

Model	Recommended Gauge (AWG, kcmil)					Crimp Terminal Part Number
	R/L1 S/L2 T/L3	U/T1 V/T2 W/T3	-, +1	+3	⊕	
4140, 4168	-	-	-	-	4	P4-56R-E S4-56R-E
4208	-	-	-	-	4	P4-38R-E S4-38R-E
	1/0 × 2P	1/0 × 2P	-	1/0 × 2P	-	S1/0-38R-X
	-	-	3/0 × 2P	-	-	S3/0-38R-5
4250	-	-	-	-	2	P2-38R-X S2-38R-X
	-	-	-	1/0 × 2P	-	S1/0-38R-X
	2/0 × 2P	2/0 × 2P	-	-	-	S2/0-38R-X
	-	-	3/0 × 2P	-	-	S3/0-38R-5
4302	-	-	-	-	2	P2-38R-X S2-38R-X
	-	-	-	1/0 × 2P	-	S1/0-38R-X
	3/0 × 2P	3/0 × 2P	-	-	-	S3/0-38R-5
	-	-	4/0 × 2P	-	-	S4/0-38R-5
4371	-	-	-	-	1	S2-12R-X
	-	-	-	3/0 × 2P	-	S3/0-12R-5
	250 × 2P	250 × 2P	-	-	-	S250-12R-5
	-	-	350 × 2P	-	-	LCA350-12-X LCAX350-12-6
4414	-	-	-	-	1	S2-12R-X
	-	-	-	4/0 × 2P	-	S4/0-12R-5
	300 × 2P	300 × 2P	-	-	-	LCA300-12-X LCAX300-12-6
	-	-	400 × 2P	-	-	LCA400-12-6
4477	-	-	-	-	1/0	S1/0-12R-X
	-	-	-	3/0 × 4P	-	S3/0-12R-5
	-	4/0 × 4P	4/0 × 4P	-	-	S4/0-12R-5
	250 × 4P	-	-	-	-	S250-12R-5
4568	-	-	-	-	2/0	S2/0-12R-X
	-	-	-	3/0 × 4P	-	S3/0-12R-5
	-	4/0 × 4P	-	-	-	S4/0-12R-5
	250 × 4P	-	-	-	-	S250-12R-5
	-	-	300 × 4P	-	-	LCA300-12-X LCAX300-12-6
4605	-	-	-	-	2/0	S2/0-12R-X
	-	-	-	4/0 × 4P	-	S4/0-12R-5
	300 × 4P	300 × 4P	-	-	-	LCA300-12-X LCAX300-12-6
	-	-	400 × 4P	-	-	LCA400-12-6

Model	Recommended Gauge (AWG, kcmil)					Crimp Terminal Part Number
	R/L1 S/L2 T/L3	U/T1 V/T2 W/T3	-, +1	+3	⊕	
4720	-	-	-	-	2/0	S2/0-12R-X
	-	-	-	4/0 × 4P	-	S4/0-12R-5
	300 × 4P	300 × 4P	-	-	-	LCA300-12-X LCAX300-12-6
	-	-	400 × 4P	-	-	LCA400-12-6

◆ Factory-Recommended Branch Circuit Protection for UL Listing

Yaskawa recommends installing one of the following types of branch circuit protection to maintain compliance with UL 508C. Semiconductor protective type fuses are preferred. Alternate branch circuit protection devices are also listed. Maximum Time Delay fuse is 175% of drive full load output amps (FLA). This covers any Class CC, J, or T class fuse. Refer to [Table 12.2](#) to [Table 12.3](#) for the recommended fuses.

⚠ WARNING *Electrical Shock Hazard. After the drive blows a fuse or trips a GFCI, do not immediately energize the drive or operate peripheral devices. Wait for the time specified on the warning label at a minimum and make sure that all indicators are OFF. Then check the wiring and peripheral device ratings to find the cause of the problem. If you do not know the cause of the problem, contact Yaskawa before you energize the drive or peripheral devices. If you do not fix the problem before you operate the drive or peripheral devices, it can cause serious injury or death.*

- 200 V class
Use the fuses specified in this document to prepare the drive for use on a circuit that supplies not more than 100,000 RMS and not more than 240 Vac when there is a short circuit in the power supply.
- 400 V class
Use the fuses specified in this document to prepare the drive for use on a circuit that supplies not more than 100,000 RMS and not more than 480 Vac when there is a short circuit in the power supply.

The user must provide branch circuit protection to protect input branch circuits as specified by the National Electric Code (NEC), the Canadian Electric Code, Part I (CEC), and local codes.

■ 200 V Class

Table 12.2 Factory Recommended Fuses for 200 V Class

Drive Model	Semiconductor Fuse Manufacturer: EATON/Bussmann	Alternate Time-Delay Class CC, J, or T */ Maximum Amp Rating (Maximum SCCR (kA))
2004	FWH-45B	6 (65)
2006	FWH-45B	10 (65)
2008	FWH-45B	12 (65)
2010	FWH-45B	15 (65)
2012	FWH-50B FWH-80B *2	20 (65)
2018	FWH-80B FWH-100B *2	30 (65)
2021	FWH-80B FWH-100B *2	35 (65)
2030	FWH-125B	50 (100)
2042	FWH-200B	70 (100)
2056	FWH-225A	90 (100)
2070	FWH-250A	110 (100)
2082	FWH-225A FWH-250A *2	125 (100)

Drive Model	Semiconductor Fuse Manufacturer: EATON/Bussmann	Alternate Time-Delay Class CC, J, or T ^{*1} Maximum Amp Rating (Maximum SCCR (kA))
2110	FWH-225A FWH-250A ^{*2}	175 (100)
2138	FWH-275A FWH-300A ^{*2}	225 (100)
2169	FWH-275A FWH-350A ^{*2}	250 (100)
2211	FWH-325A FWH-450A ^{*2}	350 (100)
2257	FWH-600A	400 (100)
2313	FWH-800A	500 (100)
2360	FWH-1000A	600 (100) ^{*3}
2415	FWH-1000A	800 (100) ^{*3}

*1 Class T fuses are fast-acting (non-time delay only).

*2 Yaskawa recommends a fuse with a larger rated current for cyclical load applications that frequently approach 150 % overload.

*3 For fuses rated 601 - 800 amps, Class T fuses must be used.

■ 400 V Class

Table 12.3 Factory Recommended Fuses for 400 V Class

Drive Model	Semiconductor Fuse Manufacturer: EATON/Bussmann	Alternate Time-Delay Class CC, J, or T ^{*1} Maximum Amp Rating (Maximum SCCR (kA))
4002	FWH-50B	3.5 (100)
4004	FWH-50B	7 (100)
4005	FWH-50B	9 (100)
4007	FWH-60B	12 (100)
4009	FWH-60B	15 (100)
4012	FWH-60B	20 (100)
4018	FWH-80B	30 (100)
4023	FWH-90B	40 (100)
4031	FWH-150B	50 (100)
4038	FWH-200B	60 (100)
4044	FWH-200B	70 (100)
4060	FWH-225A	100 (100)
4075	FWH-250A	125 (100)
4089	FWH-275A	150 (100)
4103	FWH-275A	175 (100)
4140	FWH-300A	225 (100)
4168	FWH-325A FWH-400A ^{*2}	250 (100)
4208	FWH-500A	350 (100)
4250	FWH-600A	400 (100)
4302	FWH-700A	500 (100)
4371	FWH-800A	Not applicable
4414	FWH-1000A	Not applicable

Drive Model	Semiconductor Fuse Manufacturer: EATON/Bussmann	Alternate Time-Delay Class CC, J, or T ^{*1} Maximum Amp Rating (Maximum SCCR (kA))
4477	FWH-1200A	Not applicable
4568	FWH-1200A	Not applicable
4605	FWH-1400A	Not applicable
4720	FWH-1400A	Not applicable

*1 Class T fuses are fast-acting (non-time delay only).

*2 Yaskawa recommends a fuse with a larger rated current for cyclical load applications that frequently approach 150 % overload.

■ UL Standards Compliance for DC Power Supply Input

To comply with UL Standards, install a fuse for the DC power supply input.

Figure 12.2 shows a wiring example for a DC power supply that has two drives connected in parallel.

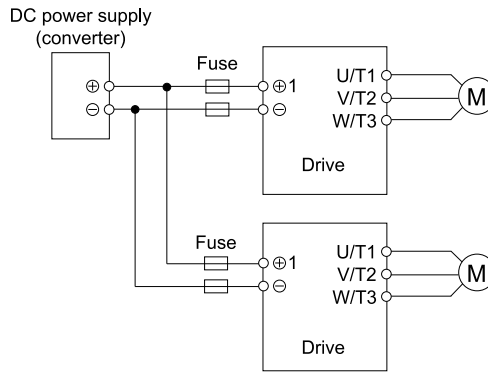

Figure 12.2 Wiring Example for DC Power Supply Input

⚠ WARNING Electrical Shock Hazard. Do not ground the main circuit bus. Incorrect wiring can cause serious injury or death.

Note:

- Install a fuse for each drive when operating more than one drive. If one fuse opens, replace all fuses.

Refer to Table 12.4 and Table 12.5 for the recommended fuses.

Table 12.4 Recommended DC Input Fuse (Three-Phase 200 V Class)

Drive Model	Fuse Manufacturer: Bussmann	
	Model	Quantity
2004	FWH-45B	2
2006		
2008		
2010		
2012	FWH-50B, or FWH-80B ^{*1} , or FWH-100B ^{*1}	2
2018	FWH-80B, or FWH-100B ^{*1}	2
2021		
2030	FWH-125B	2
2042	FWH-150B	2
2056	FWH-200B	2
2070	FWH-225A	2
2082	FWH-250A	2
2110		
2138		
	FWH-300A	2

Drive Model	Fuse Manufacturer: Bussmann	
	Model	Quantity
2169	FWH-350A	2
2211	FWH-450A	2
2257	FWH-600A	2
2313	FWH-800A	2
2360	FWH-1000A	2
2415		

*1 Yaskawa recommends a fuse with a larger rated current for cyclic load applications that frequently approach 150% overload.

Table 12.5 Recommended DC Input Fuse (Three-Phase 400 V Class)

Drive Model	Fuse Manufacturer: Bussmann	
	Model	Quantity
4002	FWP-50B	2
4004		
4005		
4007	FWP-60B	2
4009		
4012		
4018	FWP-80B	2
4023	FWP-90B	2
4031	FWP-150A	2
4038	FWP-200A	2
4044		
4060	FWP-225A	2
4075	FWP-250A	2
4089	FWP-300A	2
4103		
4140	FWP-350A	2
4168	FWP-450A	2
4208	FWP-600A	2
4250	FWP-700A	2
4302	FWP-800A	2
4371	Not applicable	
4414		
4477		
4568		
4605		
4720		

◆ Low Voltage Wiring for Control Circuit Terminals

You must provide low voltage wiring as specified by the National Electric Code (NEC), the Canadian Electric Code, Part I (CEC), and local codes. Yaskawa recommends the NEC class 1 circuit conductor. Use the UL approved class 2 power supply for external power supply.

Table 12.6 Control Circuit Terminal Power Supplies

Input/Output	Terminals	Power Supply Specifications
Digital input	S1 to S8, SN, SC, SP	Uses the LVLC power supply in the drive. Use the UL Listed class 2 power supply for external power supply.
Analog input	A1 to A3, AC, +V, -V	Uses the LVLC power supply in the drive. Use the UL Listed class 2 power supply for external power supply.
Analog output	FM, AM, AC	Uses the LVLC power supply in the drive.
Pulse train output	MP, AC	Uses the LVLC power supply in the drive. Use the UL Listed class 2 power supply for external power supply.
Pulse train input	RP, AC	Uses the LVLC power supply in the drive. Use the UL Listed class 2 power supply for external power supply.
Safe disable input	H1, H2, HC	Uses the LVLC power supply in the drive. Use the UL Listed class 2 power supply for external power supply.
Serial communication input/output	D+, D-, AC	Uses the LVLC power supply in the drive. Use the UL Listed class 2 power supply for external power supply.
24 V external power supply	PS, AC	Use the UL Listed class 2 power supply.

◆ Drive Motor Overload and Overheat Protection

The drive motor overload and overheat protection function complies with the National Electric Code (NEC) and the Canadian Electric Code, Part I (CEC).

Set the Motor Rated Current and *L1-01 through L1-04 [Motor Overload Protection Select]* correctly to enable motor overload and overheat protection.

Refer to the control method and set the motor rated current with *E2-01 [Motor Rated Current (FLA)]*, *E5-03 [PM Motor Rated Current (FLA)]*, or *E9-06 [Motor Rated Current (FLA)]*.

■ E2-01: Motor Rated Current (FLA)

No. (Hex.)	Name	Description	Default (Range)
E2-01 (030E)	Motor Rated Current (FLA)	<input type="checkbox"/> V/f <input type="checkbox"/> CL-V/f <input type="checkbox"/> OLV <input type="checkbox"/> CLV <input type="checkbox"/> AOLV <input type="checkbox"/> OLVP/PM <input type="checkbox"/> AOLV/PM <input type="checkbox"/> CLV/PM <input type="checkbox"/> EZOLV Sets the motor rated current in amps.	Determined by o2-04, C6-01 (10% to 200% of the drive rated current)

Note:

- If *E2-01* < *E2-03 [Motor No-Load Current]* the drive will detect *oPE02 [Parameter Range Setting Error]*.
- The default settings and setting ranges are in these units:
–0.01 A: 2004 to 2042, 4002 to 4023
–0.1 A: 2056 to 2415, 4031 to 4720

The value set for *E2-01* becomes the reference value for motor protection, the torque limit, and torque control. Enter the motor rated current as written on the motor nameplate. The value of *E2-01* is automatically set to the value input for “Motor Rated Current” by the Auto-Tuning process.

■ E5-03: PM Motor Rated Current (FLA)

No. (Hex.)	Name	Description	Default (Range)
E5-03 (032B)	PM Motor Rated Current (FLA)	<input type="checkbox"/> V/f <input type="checkbox"/> CL-V/f <input type="checkbox"/> OLV <input type="checkbox"/> CLV <input type="checkbox"/> AOLV <input checked="" type="checkbox"/> OLVP/PM <input checked="" type="checkbox"/> AOLV/PM <input checked="" type="checkbox"/> CLV/PM <input type="checkbox"/> EZOLV Sets the PM motor rated current (FLA).	Determined by o2-04, C6-01 (10% to 200% of the drive rated current)

Note:

- When the drive model changes, the display units for this parameter also change.
- 0.01 A: 2004 to 2042, 4002 to 4023
 - 0.1 A: 2056 to 2415, 4031 to 4720

The drive automatically sets *E5-03* to the value input for “PM Motor Rated Current” after you do these types of Auto-Tuning:

- PM Motor Parameter Settings
- PM Stationary Auto-Tuning
- PM StaTun for Stator Resistance
- PM Rotational Auto-Tuning

■ E9-06: Motor Rated Current (FLA)

No. (Hex.)	Name	Description	Default (Range)
E9-06 (11E9)	Motor Rated Current (FLA)	<div style="display: flex; justify-content: space-between; align-items: center;"> V/f CL-V/f OLV CLV AOLV OLV/PM AOLV/PM CLV/PM EZOLV </div> Sets the motor rated current in amps.	Determined by E9-01 and o2-04 (10% to 200% of the drive rated current)

Note:

When the drive model changes, the display units for this parameter also change.

- 0.01 A: 2004 to 2042, 4002 to 4023
- 0.1 A: 2056 to 2415, 4031 to 4720

The setting value of *E9-06* is the reference value for motor protection. Enter the motor rated current shown on the motor nameplate. Auto-Tuning the drive will automatically set *E9-06* to the value input for “Motor Rated Current”.

■ L1-01: Motor Overload (oL1) Protection

No. (Hex.)	Name	Description	Default (Range)
L1-01 (0480)	Motor Overload (oL1) Protection	<div style="display: flex; justify-content: space-between; align-items: center;"> V/f CL-V/f OLV CLV AOLV OLV/PM AOLV/PM CLV/PM EZOLV </div> Sets the motor overload protection with electronic thermal protectors.	Determined by A1-02 (0 - 6)

This parameter enables and disables the motor overload protection with electronic thermal protectors.

The cooling capability of the motor changes when the speed control range of the motor changes. Use an electronic thermal protector that aligns with the permitted load characteristics of the motor to select motor protection.

The electronic thermal protector of the drive uses these items to calculate motor overload tolerance and supply overload protection for the motor:

- Output Current
- Output Frequency
- Motor thermal characteristics
- Time characteristics

If the drive detects motor overload, the drive will trigger an *oL1* [*Motor Overload*] and stop the drive output.

Set *H2-01* = *IF* [*Term M1-M2 Function Selection* = *Motor Overload Alarm (oL1)*] to set a motor overload alarm. If the motor overload level is more than 90% of the *oL1* detection level, the output terminal turns ON and triggers an overload alarm.

0 : Disabled

Disable motor protection when motor overload protection is not necessary or when the drive is operating more than one motor.

Refer to [Figure 12.3](#) for an example of the circuit configuration to connect more than one motor to one drive.

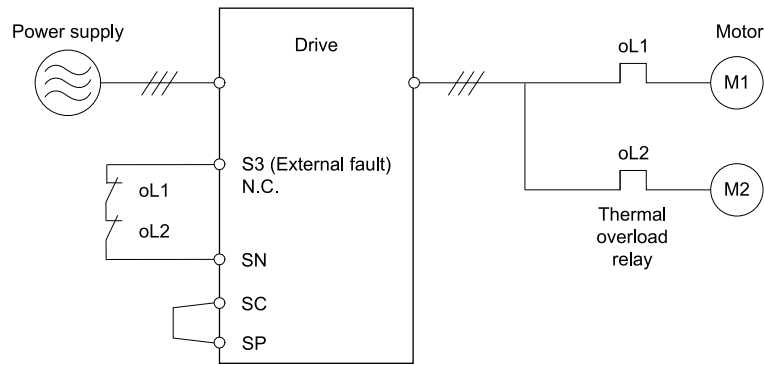

Figure 12.3 Protection Circuit Configuration to Connect More than One Motor to One Drive

NOTICE When you connect more than one motor to one drive or when the motor amp rating is higher than the drive amp rating, set L1-01 = 0 [Motor Overload (oL1) Protection = Disabled] and install thermal overload relays for each motor. The electronic thermal protection of the drive will not function and it can cause damage to the motor.

1 : Variable Torque

Use this setting for general-purpose motors with a 60 Hz base frequency.

The overload tolerance decreases as motor speed decreases because the cooling fan speed decreases and the ability of the motor to cool decreases in the low speed range.

The overload tolerance characteristics of the motor change the trigger point for the electronic thermal protector. This provides motor overheat protection from low speed to high speed across the full speed range.

Load Tolerance	Cooling Capability	Overload Characteristics (at 100% motor load)
	<p>This motor is designed to operate with commercial line power. Operate at a 60 Hz base frequency to maximize the motor cooling ability.</p>	<p>If the motor operates at frequencies less than 60 Hz, the drive will detect oL1. The drive triggers a fault relay output and the motor coasts to stop.</p>

2 : Constant Torque 10:1 Speed Range

Use this setting for drive-dedicated motors with a speed range for constant torque of 1:10.

The speed control for this motor is 10% to 100% when at 100% load. Operating slower than 10% speed at 100% load will cause motor overload.

Load Tolerance	Cooling Capability	Overload Characteristics (at 100% motor load)
	<p>This motor is designed to withstand increased temperatures during continuous operation in the low speed range (10% base frequency).</p>	<p>The motor operates continuously at 10% to 100% base frequency. Operating slower than 10% speed at 100% load will cause motor overload.</p>

3 : Constant Torque 100:1 SpeedRange

Use this setting for vector motors with a speed range for constant torque of 1:100.

The speed control for this motor is 1% to 100% when at 100% load. Operating slower than 1% speed at 100% load will cause motor overload.

Load Tolerance	Cooling Capability	Overload Characteristics (at 100% motor load)
	<p>This motor is designed to withstand increased temperatures during continuous operation in the low speed range (1% base frequency).</p>	<p>The motor operates continuously at 1% to 100% base frequency. Operating slower than 1% speed at 100% load will cause motor overload.</p>

4 : PM Variable Torque

Use this setting for PM motors with derated torque characteristics.

The overload tolerance decreases as motor speed decreases because the cooling fan speed decreases and the ability of the motor to cool decreases in the low speed range.

The overload tolerance characteristics of the motor change the trigger point for the electronic thermal protector. This provides motor overheat protection from low speed to high speed across the full speed range.

Load Tolerance	Cooling Capability	Overload Characteristics (at 100% motor load)
	<p>This motor is designed to withstand increased temperatures during continuous operation at rated speed and rated torque.</p>	<p>If the motor operates continuously at lower speed than rated rotation speed at more than 100% torque, the drive will detect <i>oLI</i>. The drive triggers a fault relay output and the motor coasts to stop.</p>

5 : PM Constant Torque

Use this setting with a PM motor for constant torque that has a speed range for constant torque of 1:500.

The speed control for this motor is 0.2% to 100% when at 100% load. Operating slower than 0.2% speed at 100% load will cause motor overload.

Load Tolerance	Cooling Capability	Overload Characteristics (at 100% motor load)
	<p>This motor is designed to withstand increased temperatures during continuous operation in the low speed range (0.2% base frequency).</p>	<p>The motor operates continuously at 0.2% to 100% rated speed. Operating slower than 0.2% speed at 100% load will cause motor overload.</p>

6 : Variable Torque (50Hz)

Use this setting for general-purpose motors with a 50 Hz base frequency.

The overload tolerance decreases as motor speed decreases because the cooling fan speed decreases and the ability of the motor to cool decreases in the low speed range.

The overload tolerance characteristics of the motor change the trigger point for the electronic thermal protector. This provides motor overheat protection from low speed to high speed across the full speed range.

Load Tolerance	Cooling Capability	Overload Characteristics (at 100% motor load)
	<p>This motor is designed to operate with commercial line power. Operate at a 50 Hz base frequency to maximize the motor cooling ability.</p>	<p>If the motor operates at frequencies less than commercial line power, the drive will detect <i>oL1</i>. The drive triggers a fault relay output and the motor coasts to stop.</p>

■ L1-02: Motor Overload Protection Time

No. (Hex.)	Name	Description	Default (Range)
L1-02 (0481)	Motor Overload Protection Time	<p>V/f CL-V/f OLV CLV AOLV OLV/PM AOLV/PM CLV/PM EZOLV</p> <p>Sets the operation time for the electronic thermal protector of the drive to prevent damage to the motor. Usually it is not necessary to change this setting.</p>	1.0 min (0.1 - 5.0 min)

Set the overload tolerance time to the length of time that the motor can operate at 150% load from continuous operation at 100% load.

When the motor operates at 150% load continuously for 1 minute after continuous operation at 100% load (hot start), the default setting triggers the electronic thermal protector.

Figure 12.4 shows an example of the electronic thermal protector operation time. Motor overload protection operates in the range between a cold start and a hot start.

This example shows a general-purpose motor operating at the base frequency with *L1-02* set to 1.0 min.

- Cold start
Shows the motor protection operation time characteristics when the overload occurs immediately after starting operation from a complete stop.
- Hot start
Shows the motor protection operation time characteristics when overload occurs from continuous operation below the motor rated current.

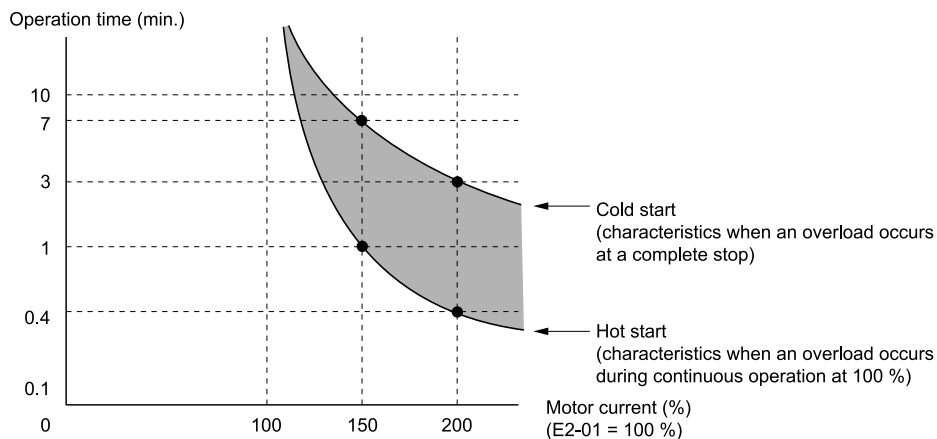

Figure 12.4 Protection Operation Time for a General-purpose Motor at Rated Output Frequency

■ L1-03: Motor Thermistor oH Alarm Select

No. (Hex.)	Name	Description	Default (Range)
L1-03 (0482)	Motor Thermistor oH Alarm Select	<input type="checkbox"/> V/f <input type="checkbox"/> CL-V/f <input type="checkbox"/> OLV <input type="checkbox"/> CLV <input type="checkbox"/> AOLV <input type="checkbox"/> OLV/PM <input type="checkbox"/> AOLV/PM <input type="checkbox"/> CLV/PM <input type="checkbox"/> EZOLV Sets drive operation when the PTC input signal entered into the drive is at the oH3 [Motor Overheat Alarm] detection level.	3 (0 - 3)

0 : Ramp to Stop

The drive ramps the motor to stop in the deceleration time. Fault relay output terminal MA-MC turns ON and MB-MC turns OFF.

1 : Coast to Stop

The output turns OFF and the motor coasts to stop. Fault relay output terminal MA-MC turns ON, and MB-MC turns OFF.

2 : Fast Stop (Use C1-09)

The drive stops the motor in the deceleration time set in C1-09 [Fast Stop Time]. Fault relay output terminal MA-MC turns ON, and MB-MC turns OFF.

3 : Alarm Only

The keypad shows oH3, and operation continues. The output terminal set for Alarm [H2-01 to H2-03 = 10] turns ON.

■ L1-04: Motor Thermistor oH Fault Select

No. (Hex.)	Name	Description	Default (Range)
L1-04 (0483)	Motor Thermistor oH Fault Select	<input type="checkbox"/> V/f <input type="checkbox"/> CL-V/f <input type="checkbox"/> OLV <input type="checkbox"/> CLV <input type="checkbox"/> AOLV <input type="checkbox"/> OLV/PM <input type="checkbox"/> AOLV/PM <input type="checkbox"/> CLV/PM <input type="checkbox"/> EZOLV Sets the drive operation when the PTC input signal to the drive is at the oH4 [Motor Overheat Fault (PTC Input)] detection level.	1 (0 - 2)

0 : Ramp to Stop

The drive ramps the motor to stop in the deceleration time. Fault relay output terminal MA-MC turns ON and MB-MC turns OFF.

1 : Coast to Stop

The output turns OFF and the motor coasts to stop. Fault relay output terminal MA-MC turns ON, and MB-MC turns OFF.

2 : Fast Stop (Use C1-09)

The drive stops the motor in the deceleration time set in C1-09 [Fast Stop Time]. Fault relay output terminal MA-MC turns ON, and MB-MC turns OFF.

13 European Standards



Figure 13.1 CE Mark

The CE Mark identifies that the product meets environmental and safety standards in the European Union. Products manufactured, sold, or imported in the European Union must display the CE Mark.

European Union standards include standards for electrical appliances (Low Voltage Directive), standards for electrical noise (EMC Directive), and standards for machinery (Machinery Directive).

This product displays the CE Mark in accordance with the Low Voltage Directive and the Machinery Directive.

Table 13.1 Harmonized Standard

European Directive	Harmonized Standard
CE Low Voltage Directive Compliance 2014/35/EU	IEC/EN 61800-5-1:2007
Machinery Directive 2006/42/EC	<ul style="list-style-type: none"> • EN ISO 13849-1:2015 (PL e (Cat.III)) • IEC 62061(ed.1);am1;am2 (SILCL3) • EN 62061:2005/A2:2015 (SILCL3) • IEC/EN 61800-5-2:2016

The customer must display the CE Mark on the final device containing this product. Customers must verify that the final device complies with EU standards.

◆ EU Declaration of Conformity

Go to www.yaskawa.com and search for "EU Declaration of Conformity" to get an original copy of the EU Declaration of Conformity.

Yaskawa declares that this product complies with the following directives and standards at our sole responsibility.

◆ CE Low Voltage Directive Compliance

It has been confirmed that this product complies with the CE Low Voltage Directive by conducting a test according to IEC/EN 61800-5-1:2007.

The following conditions must be satisfied for machines and devices incorporating this product to comply with the CE Low Voltage Directive.

■ Area of Use

Install this product in a location with Overvoltage Category III and pollution degree 2 or less as specified in IEC/CE 60664.

■ Guarding against Debris

When installing IP20 enclosure drives (models: 2xxxxB, 4xxxxB), use an enclosure that does not let unwanted material enter the drive from above or below.

■ Electrical Installation

Refer to [Figure 13.2](#) for an example of a drive that is wired to comply with the CE Low Voltage Directive.

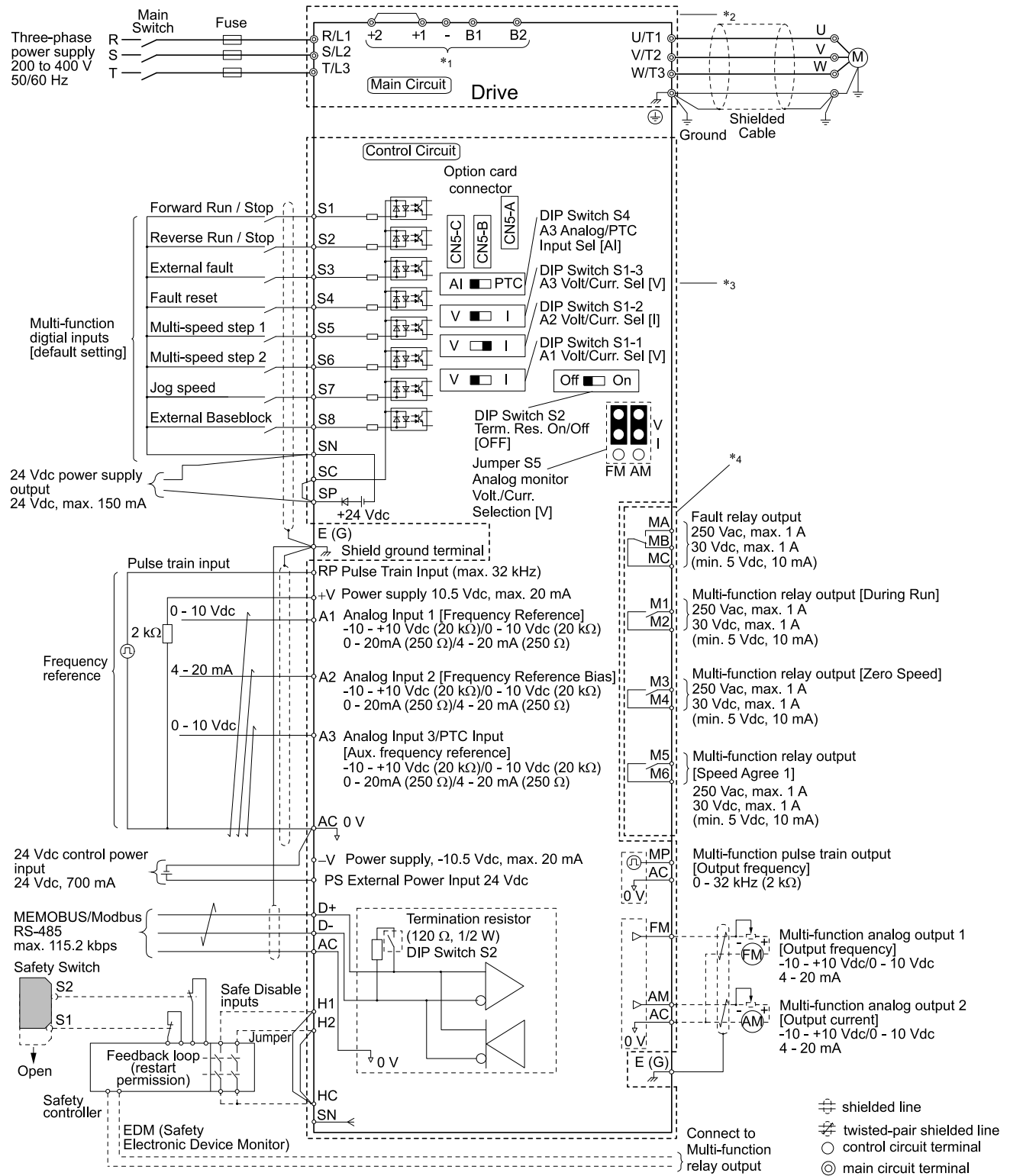

Figure 13.2 Wiring Diagram for CE Low Voltage Directive Compliance

*1 Use terminals -, +1, +2, B1, and B2 to connect options to the drive.

⚠ WARNING Sudden Movement Hazard. Make sure that the polarity is correct before you send a Run command. If the drive incorrectly detects the polarity, the drive can rotate in the direction opposite of the Run command and cause serious injury or death.

*2 For circuit protection, the main circuit is separated from the surface case that can touch the main circuit.

- *3 The control circuit is a Safety Extra-Low Voltage circuit. Separate this circuit from other circuits with reinforced insulation. Make sure that the Safety Extra-Low Voltage circuit is connected as specified.
- *4 Reinforced insulation separates the output terminals from other circuits. Users can also connect circuits that are not Safety Extra-Low Voltage circuits if the drive output is 250 Vac 1 A maximum or 30 Vdc 1 A maximum.

■ Main Circuit Wire Gauges and Tightening Torques

⚠ WARNING *Electrical Shock Hazard. Only connect factory-recommended devices or circuits to drive terminals B1, B2, -, +1, +2, and +3 terminals. Do not connect AC power to these terminals. Incorrect wiring can cause damage to the drive and serious injury or death from fire.*

Note:

- The recommended wire gauges are based on drive continuous current ratings with 75 °C (167 °F) 600 V class 2 heat-resistant indoor PVC wire. Assume these conditions:
 - Ambient temperature: 40 °C (104 °F) or lower
 - Wiring distance: 100 m (328 ft) or shorter
 - Normal Duty Rated current value
- Refer to the instruction manual for each device for recommended wire gauges to connect peripheral devices or options to terminals +1, +2, +3, -, B1, and B2. Contact Yaskawa or your nearest sales representative if the recommended wire gauges for the peripheral devices or options are out of the range of the applicable gauges for the drive.

Three-Phase 200 V Class

Model	Terminals	Recommended Gauge mm ²	Applicable Gauge (IP20 Applicable Gauge ^{*1}) mm ²	Wire Stripping Length ^{*2} mm	Terminal Screw		Tightening Torque N·m (in·lb)
					Size	Shape	
2004	R/L1, S/L2, T/L3	2.5	2.5 - 10 (2.5 - 10)	10	M4	Slotted (-)	1.5 - 1.7 (13.5 - 15)
	U/T1, V/T2, W/T3	2.5	2.5 - 10 (2.5 - 10)	10	M4	Slotted (-)	1.5 - 1.7 (13.5 - 15)
	-, +1, +2	2.5	2.5 - 16 (2.5 - 16)	18	M5	Slotted (-)	2.3 - 2.5 (19.8 - 22) ^{*3}
	B1, B2	2.5	2.5 - 4 (2.5 - 4)	10	M4	Slotted (-)	1.5 - 1.7 (13.5 - 15)
	⊕	2.5 ^{*4}	2.5 - 10 (-)	-	M4	Phillips/slotted combo	1.2 - 1.5 (10.6 - 13.3)
2006	R/L1, S/L2, T/L3	2.5	2.5 - 10 (2.5 - 10)	10	M4	Slotted (-)	1.5 - 1.7 (13.5 - 15)
	U/T1, V/T2, W/T3	2.5	2.5 - 10 (2.5 - 10)	10	M4	Slotted (-)	1.5 - 1.7 (13.5 - 15)
	-, +1, +2	2.5	2.5 - 16 (2.5 - 16)	18	M5	Slotted (-)	2.3 - 2.5 (19.8 - 22) ^{*3}
	B1, B2	2.5	2.5 - 4 (2.5 - 4)	10	M4	Slotted (-)	1.5 - 1.7 (13.5 - 15)
	⊕	2.5 ^{*4}	2.5 - 10 (-)	-	M4	Phillips/slotted combo	1.2 - 1.5 (10.6 - 13.3)
2008	R/L1, S/L2, T/L3	2.5	2.5 - 10 (2.5 - 10)	10	M4	Slotted (-)	1.5 - 1.7 (13.5 - 15)
	U/T1, V/T2, W/T3	2.5	2.5 - 10 (2.5 - 10)	10	M4	Slotted (-)	1.5 - 1.7 (13.5 - 15)
	-, +1, +2	2.5	2.5 - 16 (2.5 - 16)	18	M5	Slotted (-)	2.3 - 2.5 (19.8 - 22) ^{*3}
	B1, B2	2.5	2.5 - 4 (2.5 - 4)	10	M4	Slotted (-)	1.5 - 1.7 (13.5 - 15)
	⊕	2.5 ^{*4}	2.5 - 10 (-)	-	M4	Phillips/slotted combo	1.2 - 1.5 (10.6 - 13.3)

Model	Terminals	Recommended Gauge mm ²	Applicable Gauge (IP20 Applicable Gauge ^{*1}) mm ²	Wire Stripping Length ^{*2} mm	Terminal Screw		Tightening Torque N·m (in·lb)
					Size	Shape	
2010	R/L1, S/L2, T/L3	2.5	2.5 - 10 (2.5 - 10)	10	M4	Slotted (-)	1.5 - 1.7 (13.5 - 15)
	U/T1, V/T2, W/T3	2.5	2.5 - 10 (2.5 - 10)	10	M4	Slotted (-)	1.5 - 1.7 (13.5 - 15)
	-, +1, +2	2.5	2.5 - 16 (2.5 - 16)	18	M5	Slotted (-)	2.3 - 2.5 (19.8 - 22) ^{*3}
	B1, B2	2.5	2.5 - 4 (2.5 - 4)	10	M4	Slotted (-)	1.5 - 1.7 (13.5 - 15)
	⊕	2.5 ^{*4}	2.5 - 10 (-)	-	M4	Phillips/slotted combo	1.2 - 1.5 (10.6 - 13.3)
2012	R/L1, S/L2, T/L3	2.5	2.5 - 10 (2.5 - 10)	10	M4	Slotted (-)	1.5 - 1.7 (13.5 - 15)
	U/T1, V/T2, W/T3	2.5	2.5 - 10 (2.5 - 10)	10	M4	Slotted (-)	1.5 - 1.7 (13.5 - 15)
	-, +1, +2	2.5	2.5 - 16 (2.5 - 16)	18	M5	Slotted (-)	2.3 - 2.5 (19.8 - 22) ^{*3}
	B1, B2	2.5	2.5 - 4 (2.5 - 4)	10	M4	Slotted (-)	1.5 - 1.7 (13.5 - 15)
	⊕	2.5 ^{*4}	2.5 - 10 (-)	-	M4	Phillips/slotted combo	1.2 - 1.5 (10.6 - 13.3)
2018	R/L1, S/L2, T/L3	2.5	2.5 - 10 (2.5 - 10)	10	M4	Slotted (-)	1.5 - 1.7 (13.5 - 15)
	U/T1, V/T2, W/T3	2.5	2.5 - 10 (2.5 - 10)	10	M4	Slotted (-)	1.5 - 1.7 (13.5 - 15)
	-, +1, +2	4	2.5 - 16 (2.5 - 16)	18	M5	Slotted (-)	2.3 - 2.5 (19.8 - 22) ^{*3}
	B1, B2	2.5	2.5 - 4 (2.5 - 4)	10	M4	Slotted (-)	1.5 - 1.7 (13.5 - 15)
	⊕	2.5 ^{*4}	2.5 - 10 (-)	-	M4	Phillips/slotted combo	1.2 - 1.5 (10.6 - 13.3)
2021	R/L1, S/L2, T/L3	6	2.5 - 10 (2.5 - 10)	10	M4	Slotted (-)	1.5 - 1.7 (13.5 - 15)
	U/T1, V/T2, W/T3	2.5	2.5 - 10 (2.5 - 10)	10	M4	Slotted (-)	1.5 - 1.7 (13.5 - 15)
	-, +1, +2	6	2.5 - 16 (2.5 - 16)	18	M5	Slotted (-)	2.3 - 2.5 (19.8 - 22) ^{*3}
	B1, B2	2.5	2.5 - 4 (2.5 - 4)	10	M4	Slotted (-)	1.5 - 1.7 (13.5 - 15)
	⊕	6 ^{*4}	4 - 10 (-)	-	M4	Phillips/slotted combo	1.2 - 1.5 (10.6 - 13.3)
2030	R/L1, S/L2, T/L3	10	2.5 - 10 (2.5 - 10)	10	M4	Slotted (-)	1.5 - 1.7 (13.5 - 15)
	U/T1, V/T2, W/T3	6	2.5 - 10 (2.5 - 10)	10	M4	Slotted (-)	1.5 - 1.7 (13.5 - 15)
	-, +1, +2	10	2.5 - 16 (2.5 - 16)	18	M5	Slotted (-)	2.3 - 2.5 (19.8 - 22) ^{*3}
	B1, B2	2.5	2.5 - 4 (2.5 - 4)	10	M4	Slotted (-)	1.5 - 1.7 (13.5 - 15)
	⊕	10	6 - 10 (-)	-	M5	Phillips/slotted combo	2.0 - 2.5 (17.7 - 22.1)

13 European Standards

Model	Terminals	Recommended Gauge mm ²	Applicable Gauge (IP20 Applicable Gauge ^{*1}) mm ²	Wire Stripping Length ^{*2} mm	Terminal Screw		Tightening Torque N·m (in·lb)
					Size	Shape	
2042	R/L1, S/L2, T/L3	10	2.5 - 10 (2.5 - 10)	10	M4	Slotted (-)	1.5 - 1.7 (13.5 - 15)
	U/T1, V/T2, W/T3	10	2.5 - 10 (2.5 - 10)	10	M4	Slotted (-)	1.5 - 1.7 (13.5 - 15)
	-, +1, +2	16	2.5 - 16 (2.5 - 16)	18	M5	Slotted (-)	2.3 - 2.5 (19.8 - 22) ^{*3}
	B1, B2	4	2.5 - 4 (2.5 - 4)	10	M4	Slotted (-)	1.5 - 1.7 (13.5 - 15)
	⊕	10	6 - 10 (-)	-	M5	Phillips/slotted combo	2.0 - 2.5 (17.7 - 22.1)
2056	R/L1, S/L2, T/L3	25	2.5 - 25 (10 - 25)	18	M5	Slotted (-)	2.3 - 2.5 (19.8 - 22) ^{*3}
	U/T1, V/T2, W/T3	16	2.5 - 16 (6 - 16)	18	M5	Slotted (-)	2.3 - 2.5 (19.8 - 22) ^{*3}
	-, +1, +2	35	2.5 - 35 (10 - 35)	20	M6	Hex socket cap (WAF: 5 mm)	5 - 5.5 (45 - 49)
	B1, B2	10	2.5 - 10 (2.5 - 10)	10	M4	Slotted (-)	1.5 - 1.7 (13.5 - 15)
	⊕	16	10 - 16 (-)	-	M6	Phillips/slotted combo	5.4 - 6.0 (47.8 - 53.1)
2070	R/L1, S/L2, T/L3	35	2.5 - 35 (25 - 35)	20	M6	Hex socket cap (WAF: 5 mm)	5 - 5.5 (45 - 49)
	U/T1, V/T2, W/T3	16	2.5 - 16 (16)	20	M6	Hex socket cap (WAF: 5 mm)	5 - 5.5 (45 - 49)
	-, +1, +2	50	2.5 - 50 (35 - 50)	20	M6	Hex socket cap (WAF: 5 mm)	5 - 5.5 (45 - 49)
	B1, B2	10	2.5 - 10 (2.5 - 10)	10	M4	Slotted (-)	1.5 - 1.7 (13.5 - 15)
	⊕	16	16 - 25 (-)	-	M6	Phillips/slotted combo	5.4 - 6.0 (47.8 - 53.1)
2082	R/L1, S/L2, T/L3	35	2.5 - 35 (25 - 35)	20	M6	Hex socket cap (WAF: 5 mm)	5 - 5.5 (45 - 49)
	U/T1, V/T2, W/T3	25	2.5 - 25 (16 - 25)	20	M6	Hex socket cap (WAF: 5 mm)	5 - 5.5 (45 - 49)
	-, +1, +2	50	2.5 - 50 (35 - 50)	20	M6	Hex socket cap (WAF: 5 mm)	5 - 5.5 (45 - 49)
	B1, B2	16	2.5 - 16 (2.5 - 16)	10	M4	Slotted (-)	1.5 - 1.7 (13.5 - 15)
	⊕	16	16 - 25 (-)	-	M6	Phillips/slotted combo	5.4 - 6.0 (47.8 - 53.1)
2110	R/L1, S/L2, T/L3	35	16 - 35 (25 - 35)	27	M6	Hex socket cap (WAF: 5 mm)	8 - 9 (71 - 80)
	U/T1, V/T2, W/T3	35	16 - 35 (25 - 35)	27	M6	Hex socket cap (WAF: 5 mm)	8 - 9 (71 - 80)
	-, +1	50	25 - 50 (25 - 50)	27	M8	Hex socket cap (WAF: 6 mm)	10 - 12 (89 - 107)
	B1, B2	25	6 - 25 (6 - 25)	21	M6	Slotted (-)	3 - 3.5 (27 - 31)
	⊕	16	16 - 25 (-)	-	M6	Hex bolt (+)	5.4 - 6.0 (47.8 - 53.1)

Model	Terminals	Recommended Gauge mm ²	Applicable Gauge (IP20 Applicable Gauge ^{*1}) mm ²	Wire Stripping Length ^{*2} mm	Terminal Screw		Tightening Torque N·m (in·lb)
					Size	Shape	
2138	R/L1, S/L2, T/L3	50	16 - 50 (50)	27	M6	Hex socket cap (WAF: 5 mm)	8 - 9 (71 - 80)
	U/T1, V/T2, W/T3	50	16 - 50 (50)	27	M6	Hex socket cap (WAF: 5 mm)	8 - 9 (71 - 80)
	-, +1	70	25 - 70 (50 - 70)	27	M8	Hex socket cap (WAF: 6 mm)	10 - 12 (89 - 107)
	B1, B2	35	6 - 35 (6 - 35)	21	M6	Slotted (-)	3 - 3.5 (27 - 31)
	⊕	25	25 (-)	-	M6	Hex bolt (+)	5.4 - 6.0 (47.8 - 53.1)
2169	R/L1, S/L2, T/L3	70	50 - 95 (95)	37	M10	Hex socket cap (WAF: 8 mm)	12 - 14 (107 - 124)
	U/T1, V/T2, W/T3	70	50 - 95 (95)	37	M10	Hex socket cap (WAF: 8 mm)	12 - 14 (107 - 124)
	-, -, +1, +1 ^{*5 *6}	35	16 - 50 (50)	28	M6	Hex socket cap (WAF: 5 mm)	8 - 9 (71 - 80)
	+3 ^{*6}	50	25 - 70 (50 - 70)	28	M8	Hex socket cap (WAF: 6 mm)	8 - 9 (71 - 80)
	⊕	35	25 - 50 (-)	-	M8	Hex bolt (slotted)	9.0 - 11 (79.7 - 97.4)
2211	R/L1, S/L2, T/L3	95	50 - 95 (95)	37	M10	Hex socket cap (WAF: 8 mm)	12 - 14 (107 - 124)
	U/T1, V/T2, W/T3	95	50 - 95 (95)	37	M10	Hex socket cap (WAF: 8 mm)	12 - 14 (107 - 124)
	-, -, +1, +1 ^{*5 *6}	50	16 - 50 (50)	28	M6	Hex socket cap (WAF: 5 mm)	8 - 9 (71 - 80)
	+3 ^{*6}	70	25 - 70 (50 - 70)	28	M8	Hex socket cap (WAF: 6 mm)	8 - 9 (71 - 80)
	⊕	50	25 - 50 (-)	-	M8	Hex bolt (slotted)	9.0 - 11 (79.7 - 97.4)
2257	R/L1, S/L2, T/L3	50 × 2P	25 - 95 × 2P (70 - 95 × 2P)	-	M10	Hex self-locking nut	20 (177)
	U/T1, V/T2, W/T3	50 × 2P	25 - 95 × 2P (70 - 95 × 2P)	-	M10	Hex self-locking nut	20 (177)
	-, +1	70 × 2P	35 - 120 × 2P (120 × 2P)	-	M10	Hex self-locking nut	20 (177)
	+3	35 × 2P	25 - 70 × 2P (70 × 2P)	-	M10	Hex self-locking nut	20 (177)
	⊕	95	95 - 240 (-)	-	M10	Hex bolt (slotted)	18 - 23 (159 - 204)
2313	R/L1, S/L2, T/L3	70 × 2P	25 - 95 × 2P (70 - 95 × 2P)	-	M10	Hex self-locking nut	20 (177)
	U/T1, V/T2, W/T3	70 × 2P	25 - 95 × 2P (70 - 95 × 2P)	-	M10	Hex self-locking nut	20 (177)
	-, +1	95 × 2P	35 - 120 × 2P (120 × 2P)	-	M10	Hex self-locking nut	20 (177)
	+3	50 × 2P	25 - 70 × 2P (70 × 2P)	-	M10	Hex self-locking nut	20 (177)
	⊕	95	95 - 240 (-)	-	M10	Hex bolt (slotted)	18 - 23 (159 - 204)

Model	Terminals	Recommended Gauge mm ²	Applicable Gauge (IP20 Applicable Gauge ^{*1}) mm ²	Wire Stripping Length ^{*2} mm	Terminal Screw		Tightening Torque N·m (in·lb)
					Size	Shape	
2360	R/L1, S/L2, T/L3	120 × 2P	70 - 150 × 2P (150 × 2P)	-	M12	Hex self-locking nut	35 (310)
	U/T1, V/T2, W/T3	120 × 2P	70 - 150 × 2P (150 × 2P)	-	M12	Hex self-locking nut	35 (310)
	-, +1	120 × 2P	95 - 185 × 2P (185 × 2P)	-	M12	Hex self-locking nut	35 (310)
	+3	70 × 2P	50 - 95 × 2P (-)	-	M12	Hex self-locking nut	35 (310)
	⊕	120	120 - 240 (-)	-	M12	Hex bolt (slotted)	32 - 40 (283 - 354)
2415	R/L1, S/L2, T/L3	120 × 2P	70 - 150 × 2P (150 × 2P)	-	M12	Hex self-locking nut	35 (310)
	U/T1, V/T2, W/T3	120 × 2P	70 - 150 × 2P (150 × 2P)	-	M12	Hex self-locking nut	35 (310)
	-, +1	120 × 2P	95 - 185 × 2P (185 × 2P)	-	M12	Hex self-locking nut	35 (310)
	+3	70 × 2P	50 - 95 × 2P (-)	-	M12	Hex self-locking nut	35 (310)
	⊕	120	120 - 240 (-)	-	M12	Hex bolt (slotted)	32 - 40 (283 - 354)

- *1 For IP20 protection, use wires that are in the range of applicable gauges.
- *2 Remove insulation from the ends of wires to expose the length of wire shown.
- *3 For wire gauges more than 30 mm², tighten to a tightening torque of 4.1 N·m to 4.5 N·m (36 in·lb to 40 in·lb).
- *4 Install a GFCI with this wire gauge to maintain compliance with IEC/EN 61800-5-1:2007.
- *5 Terminals - and +1 have two screws. The Recommended Gauge is the wire gauge for one terminal.
- *6 A junction terminal is necessary to connect a braking unit (CDBR series) to terminals - and +3.

Three-Phase 400 V Class

Model	Terminal	Recommended Gauge mm ²	Applicable Gauge (IP20 Applicable Gauge ^{*1}) mm ²	Wire Stripping Length ^{*2} mm	Terminal Screw		Tightening Torque N·m (in·lb)
					Size	Shape	
4002	R/L1, S/L2, T/L3	2.5	2.5 - 10 (2.5 - 10)	10	M4	Slotted (-)	1.5 - 1.7 (13.5 - 15)
	U/T1, V/T2, W/T3	2.5	2.5 - 10 (2.5 - 10)	10	M4	Slotted (-)	1.5 - 1.7 (13.5 - 15)
	-, +1, +2	2.5	2.5 - 16 (2.5 - 16)	18	M5	Slotted (-)	2.3 - 2.5 (19.8 - 22) ^{*3}
	B1, B2	2.5	2.5 - 4 (2.5 - 4)	10	M4	Slotted (-)	1.5 - 1.7 (13.5 - 15)
	⊕	2.5 ^{*4}	2.5 - 10 (-)	-	M4	Phillips/slotted combo	1.2 - 1.5 (10.6 - 13.3)
4004	R/L1, S/L2, T/L3	2.5	2.5 - 10 (2.5 - 10)	10	M4	Slotted (-)	1.5 - 1.7 (13.5 - 15)
	U/T1, V/T2, W/T3	2.5	2.5 - 10 (2.5 - 10)	10	M4	Slotted (-)	1.5 - 1.7 (13.5 - 15)
	-, +1, +2	2.5	2.5 - 16 (2.5 - 16)	18	M5	Slotted (-)	2.3 - 2.5 (19.8 - 22) ^{*3}
	B1, B2	2.5	2.5 - 4 (2.5 - 4)	10	M4	Slotted (-)	1.5 - 1.7 (13.5 - 15)
	⊕	2.5 ^{*4}	2.5 - 10 (-)	-	M4	Phillips/slotted combo	1.2 - 1.5 (10.6 - 13.3)

Model	Terminal	Recommended Gauge mm ²	Applicable Gauge (IP20 Applicable Gauge ^{*1}) mm ²	Wire Stripping Length ^{*2} mm	Terminal Screw		Tightening Torque N·m (in·lb)
					Size	Shape	
4005	R/L1, S/L2, T/L3	2.5	2.5 - 10 (2.5 - 10)	10	M4	Slotted (-)	1.5 - 1.7 (13.5 - 15)
	U/T1, V/T2, W/T3	2.5	2.5 - 10 (2.5 - 10)	10	M4	Slotted (-)	1.5 - 1.7 (13.5 - 15)
	-, +1, +2	2.5	2.5 - 16 (2.5 - 16)	18	M5	Slotted (-)	2.3 - 2.5 (19.8 - 22) ^{*3}
	B1 , B2	2.5	2.5 - 4 (2.5 - 4)	10	M4	Slotted (-)	1.5 - 1.7 (13.5 - 15)
	⊕	2.5 ^{*4}	2.5 - 10 (-)	-	M4	Phillips/slotted combo	1.2 - 1.5 (10.6 - 13.3)
4007	R/L1, S/L2, T/L3	2.5	2.5 - 10 (2.5 - 10)	10	M4	Slotted (-)	1.5 - 1.7 (13.5 - 15)
	U/T1, V/T2, W/T3	2.5	2.5 - 10 (2.5 - 10)	10	M4	Slotted (-)	1.5 - 1.7 (13.5 - 15)
	-, +1, +2	2.5	2.5 - 16 (2.5 - 16)	18	M5	Slotted (-)	2.3 - 2.5 (19.8 - 22) ^{*3}
	B1 , B2	2.5	2.5 - 4 (2.5 - 4)	10	M4	Slotted (-)	1.5 - 1.7 (13.5 - 15)
	⊕	2.5 ^{*4}	2.5 - 10 (-)	-	M4	Phillips/slotted combo	1.2 - 1.5 (10.6 - 13.3)
4009	R/L1, S/L2, T/L3	2.5	2.5 - 10 (2.5 - 10)	10	M4	Slotted (-)	1.5 - 1.7 (13.5 - 15)
	U/T1, V/T2, W/T3	2.5	2.5 - 10 (2.5 - 10)	10	M4	Slotted (-)	1.5 - 1.7 (13.5 - 15)
	-, +1, +2	2.5	2.5 - 16 (2.5 - 16)	18	M5	Slotted (-)	2.3 - 2.5 (19.8 - 22) ^{*3}
	B1 , B2	2.5	2.5 - 4 (2.5 - 4)	10	M4	Slotted (-)	1.5 - 1.7 (13.5 - 15)
	⊕	2.5 ^{*4}	2.5 - 10 (-)	-	M4	Phillips/slotted combo	1.2 - 1.5 (10.6 - 13.3)
4012	R/L1, S/L2, T/L3	2.5	2.5 - 10 (2.5 - 10)	10	M4	Slotted (-)	1.5 - 1.7 (13.5 - 15)
	U/T1, V/T2, W/T3	2.5	2.5 - 10 (2.5 - 10)	10	M4	Slotted (-)	1.5 - 1.7 (13.5 - 15)
	-, +1, +2	2.5	2.5 - 16 (2.5 - 16)	18	M5	Slotted (-)	2.3 - 2.5 (19.8 - 22) ^{*3}
	B1 , B2	2.5	2.5 - 4 (2.5 - 4)	10	M4	Slotted (-)	1.5 - 1.7 (13.5 - 15)
	⊕	2.5 ^{*4}	2.5 - 10 (-)	-	M4	Phillips/slotted combo	1.2 - 1.5 (10.6 - 13.3)
4018	R/L1, S/L2, T/L3	2.5	2.5 - 10 (2.5 - 10)	10	M4	Slotted (-)	1.5 - 1.7 (13.5 - 15)
	U/T1, V/T2, W/T3	2.5	2.5 - 10 (2.5 - 10)	10	M4	Slotted (-)	1.5 - 1.7 (13.5 - 15)
	-, +1, +2	4	2.5 - 16 (2.5 - 16)	18	M5	Slotted (-)	2.3 - 2.5 (19.8 - 22) ^{*3}
	B1 , B2	2.5	2.5 - 4 (2.5 - 4)	10	M4	Slotted (-)	1.5 - 1.7 (13.5 - 15)
	⊕	2.5 ^{*4}	2.5 - 10 (-)	-	M5	Phillips/slotted combo	2.0 - 2.5 (17.7 - 22.1)

13 European Standards

Model	Terminal	Recommended Gauge mm ²	Applicable Gauge (IP20 Applicable Gauge ^{*1}) mm ²	Wire Stripping Length ^{*2} mm	Terminal Screw		Tightening Torque N·m (in·lb)
					Size	Shape	
4023	R/L1, S/L2, T/L3	6	2.5 - 10 (2.5 - 10)	10	M4	Slotted (-)	1.5 - 1.7 (13.5 - 15)
	U/T1, V/T2, W/T3	4	2.5 - 10 (2.5 - 10)	10	M4	Slotted (-)	1.5 - 1.7 (13.5 - 15)
	-, +1, +2	6	2.5 - 16 (2.5 - 16)	18	M5	Slotted (-)	2.3 - 2.5 (19.8 - 22) ^{*3}
	B1, B2	2.5	2.5 - 4 (2.5 - 4)	10	M4	Slotted (-)	1.5 - 1.7 (13.5 - 15)
	⊕	6 ^{*4}	4 - 10 (-)	-	M5	Phillips/slotted combo	2.0 - 2.5 (17.7 - 22.1)
4031	R/L1, S/L2, T/L3	10	2.5 - 25 (10 - 25)	18	M5	Slotted (-)	2.3 - 2.5 (19.8 - 22) ^{*3}
	U/T1, V/T2, W/T3	6	2.5 - 16 (6 - 16)	18	M5	Slotted (-)	2.3 - 2.5 (19.8 - 22) ^{*3}
	-, +1, +2	10	2.5 - 35 (10 - 35)	20	M6	Hex socket cap (WAF: 5 mm)	5 - 5.5 (45 - 49)
	B1, B2	2.5	2.5 - 10 (2.5 - 10)	10	M4	Slotted (-)	1.5 - 1.7 (13.5 - 15)
	⊕	10	6 - 16 (-)	-	M6	Phillips/slotted combo	5.4 - 6.0 (47.8 - 53.1)
4038	R/L1, S/L2, T/L3	10	2.5 - 25 (10 - 25)	18	M5	Slotted (-)	2.3 - 2.5 (19.8 - 22) ^{*3}
	U/T1, V/T2, W/T3	6	2.5 - 16 (6 - 16)	18	M5	Slotted (-)	2.3 - 2.5 (19.8 - 22) ^{*3}
	-, +1, +2	16	2.5 - 35 (10 - 35)	20	M6	Hex socket cap (WAF: 5 mm)	5 - 5.5 (45 - 49)
	B1, B2	4	2.5 - 10 (2.5 - 10)	10	M4	Slotted (-)	1.5 - 1.7 (13.5 - 15)
	⊕	10	6 - 16 (-)	-	M6	Phillips/slotted combo	5.4 - 6.0 (47.8 - 53.1)
4044	R/L1, S/L2, T/L3	16	2.5 - 16 (4 - 16)	18	M5	Slotted (-)	2.3 - 2.5 (19.8 - 22) ^{*3}
	U/T1, V/T2, W/T3	10	2.5 - 10 (6 - 10)	18	M5	Slotted (-)	2.3 - 2.5 (19.8 - 22) ^{*3}
	-, +1, +2	25	2.5 - 25 (6 - 25)	18	M5	Slotted (-)	2.3 - 2.5 (19.8 - 22) ^{*3}
	B1, B2	6	2.5 - 6 (2.5 - 6)	10	M4	Slotted (-)	1.5 - 1.7 (13.5 - 15)
	⊕	16	10 - 25 (-)	-	M6	Phillips/slotted combo	5.4 - 6.0 (47.8 - 53.1)
4060	R/L1, S/L2, T/L3	16	2.5 - 16 (4 - 16)	18	M5	Slotted (-)	2.3 - 2.5 (19.8 - 22) ^{*3}
	U/T1, V/T2, W/T3	16	2.5 - 16 (6 - 16)	18	M5	Slotted (-)	2.3 - 2.5 (19.8 - 22) ^{*3}
	-, +1	25	2.5 - 25 (6 - 25)	18	M5	Slotted (-)	2.3 - 2.5 (19.8 - 22) ^{*3}
	B1, B2	10	2.5 - 10 (2.5 - 10)	10	M4	Slotted (-)	1.5 - 1.7 (13.5 - 15)
	⊕	16	10 - 25 (-)	-	M6	Phillips/slotted combo	5.4 - 6.0 (47.8 - 53.1)

Model	Terminal	Recommended Gauge mm ²	Applicable Gauge (IP20 Applicable Gauge ^{*1}) mm ²	Wire Stripping Length ^{*2} mm	Terminal Screw		Tightening Torque N·m (in·lb)
					Size	Shape	
4075	R/L1, S/L2, T/L3	25	2.5 - 25 (2.5 - 25)	18	M5	Slotted (-)	2.3 - 2.5 (19.8 - 22) ^{*3}
	U/T1, V/T2, W/T3	25	2.5 - 25 (2.5 - 25)	18	M5	Slotted (-)	2.3 - 2.5 (19.8 - 22) ^{*3}
	-, +1	25	2.5 - 25 (4 - 25)	18	M5	Slotted (-)	2.3 - 2.5 (19.8 - 22) ^{*3}
	B1 , B2	10	2.5 - 10 (2.5 - 10)	10	M4	Slotted (-)	1.5 - 1.7 (13.5 - 15)
	⊕	16	16 - 25 (-)	-	M6	Hex bolt (+)	5.4 - 6.0 (47.8 - 53.1)
4089	R/L1, S/L2, T/L3	25	2.5 - 25 (10 - 25)	18	M5	Slotted (-)	2.3 - 2.5 (19.8 - 22) ^{*3}
	U/T1, V/T2, W/T3	25	2.5 - 25 (10 - 25)	18	M5	Slotted (-)	2.3 - 2.5 (19.8 - 22) ^{*3}
	-, +1	35	2.5 - 35 (16 - 35)	20	M6	Hex socket cap (WAF: 5 mm)	5 - 5.5 (45 - 49)
	B1 , B2	16	2.5 - 16 (4 - 16)	18	M5	Slotted (-)	2.3 - 2.5 (19.8 - 22) ^{*3}
	⊕	16	16 - 25 (-)	-	M6	Hex bolt (+)	5.4 - 6.0 (47.8 - 53.1)
4103	R/L1, S/L2, T/L3	35	16 - 50 (50)	27	M6	Hex socket cap (WAF: 5 mm)	8 - 9 (71 - 80)
	U/T1, V/T2, W/T3	35	16 - 50 (50)	27	M6	Hex socket cap (WAF: 5 mm)	8 - 9 (71 - 80)
	-, +1	50	25 - 70 (50 - 70)	27	M8	Hex socket cap (WAF: 6 mm)	10 - 12 (89 - 107)
	B1 , B2	25	6 - 35 (6 - 35)	21	M6	Slotted (-)	3 - 3.5 (27 - 31)
	⊕	16	16 - 25 (-)	-	M6	Hex bolt (+)	5.4 - 6.0 (47.8 - 53.1)
4140	R/L1, S/L2, T/L3	50	50 - 95 (95)	37	M10	Hex socket cap (WAF: 8 mm)	12 - 14 (107 - 124)
	U/T1, V/T2, W/T3	50	50 - 95 (95)	37	M10	Hex socket cap (WAF: 8 mm)	12 - 14 (107 - 124)
	-, -, +1 , +1 ^{*5}	25	16 - 50 (50)	28	M6	Hex socket cap (WAF: 5 mm)	8 - 9 (71 - 80)
	B1 , B2 ^{*6}	50	25 - 70 (50 - 70)	28	M8	Hex socket cap (WAF: 6 mm)	8 - 9 (71 - 80)
	⊕	25	25 - 50 (-)	-	M8	Hex bolt (slotted)	9.0 - 11 (79.7 - 97.4)
4168	R/L1, S/L2, T/L3	70	50 - 95 (95)	37	M10	Hex socket cap (WAF: 8 mm)	12 - 14 (107 - 124)
	U/T1, V/T2, W/T3	70	50 - 95 (95)	37	M10	Hex socket cap (WAF: 8 mm)	12 - 14 (107 - 124)
	-, -, +1 , +1 ^{*5}	35	16 - 50 (50)	28	M6	Hex socket cap (WAF: 5 mm)	8 - 9 (71 - 80)
	B1 , B2 ^{*6}	50	25 - 70 (50 - 70)	28	M8	Hex socket cap (WAF: 6 mm)	8 - 9 (71 - 80)
	⊕	35	25 - 50 (-)	-	M8	Hex bolt (slotted)	9.0 - 11 (79.7 - 97.4)

Model	Terminal	Recommended Gauge mm ²	Applicable Gauge (IP20 Applicable Gauge *1) mm ²	Wire Stripping Length *2 mm	Terminal Screw		Tightening Torque N·m (in·lb)
					Size	Shape	
4208	R/L1, S/L2, T/L3	50 × 2P	25 - 95 × 2P (70 - 95 × 2P)	-	M10	Hex self-locking nut	20 (177)
	U/T1, V/T2, W/T3	50 × 2P	25 - 95 × 2P (70 - 95 × 2P)	-	M10	Hex self-locking nut	20 (177)
	-, +1	70 × 2P	35 - 120 × 2P (120 × 2P)	-	M10	Hex self-locking nut	20 (177)
	+3	35 × 2P	25 - 70 × 2P (70 × 2P)	-	M10	Hex self-locking nut	20 (177)
	⊕	50	50 - 240 (-)	-	M10	Hex bolt (slotted)	18 - 23 (159 - 204)
4250	R/L1, S/L2, T/L3	50 × 2P	25 - 95 × 2P (70 - 95 × 2P)	-	M10	Hex self-locking nut	20 (177)
	U/T1, V/T2, W/T3	50 × 2P	25 - 95 × 2P (70 - 95 × 2P)	-	M10	Hex self-locking nut	20 (177)
	-, +1	70 × 2P	35 - 120 × 2P (120 × 2P)	-	M10	Hex self-locking nut	20 (177)
	+3	50 × 2P	25 - 70 × 2P (70 × 2P)	-	M10	Hex self-locking nut	20 (177)
	⊕	70	70 - 240 (-)	-	M10	Hex bolt (slotted)	18 - 23 (159 - 204)
4302	R/L1, S/L2, T/L3	70 × 2P	25 - 95 × 2P (70 - 95 × 2P)	-	M10	Hex self-locking nut	20 (177)
	U/T1, V/T2, W/T3	70 × 2P	25 - 95 × 2P (70 - 95 × 2P)	-	M10	Hex self-locking nut	20 (177)
	-, +1	95 × 2P	35 - 120 × 2P (120 × 2P)	-	M10	Hex self-locking nut	20 (177)
	+3	70 × 2P	25 - 70 × 2P (70 × 2P)	-	M10	Hex self-locking nut	20 (177)
	⊕	95	95 - 240 (-)	-	M10	Hex bolt (slotted)	18 - 23 (159 - 204)
4371	R/L1, S/L2, T/L3	120 × 2P	70 - 150 × 2P (150 × 2P)	-	M12	Hex self-locking nut	35 (310)
	U/T1, V/T2, W/T3	120 × 2P	70 - 150 × 2P (150 × 2P)	-	M12	Hex self-locking nut	35 (310)
	-, +1	120 × 2P	95 - 185 × 2P (185 × 2P)	-	M12	Hex self-locking nut	35 (310)
	+3	70 × 2P	50 - 95 × 2P (-)	-	M12	Hex self-locking nut	35 (310)
	⊕	120	120 - 240 (-)	-	M12	Hex bolt (slotted)	32 - 40 (283 - 354)
4414	R/L1, S/L2, T/L3	120 × 2P	70 - 150 × 2P (150 × 2P)	-	M12	Hex self-locking nut	35 (310)
	U/T1, V/T2, W/T3	120 × 2P	70 - 150 × 2P (150 × 2P)	-	M12	Hex self-locking nut	35 (310)
	-, +1	120 × 2P	95 - 185 × 2P (185 × 2P)	-	M12	Hex self-locking nut	35 (310)
	+3	95 × 2P	50 - 95 × 2P (-)	-	M12	Hex self-locking nut	35 (310)
	⊕	95	35 - 240 (-)	-	M12	Hex bolt (slotted)	32 - 40 (283 - 354)

Model	Terminal	Recommended Gauge mm ²	Applicable Gauge (IP20 Applicable Gauge *1) mm ²	Wire Stripping Length *2 mm	Terminal Screw		Tightening Torque N·m (in·lb)
					Size	Shape	
4477	R/L1, S/L2, T/L3	120 × 4P	70 - 150 × 4P (150 × 4P)	-	M12	Hex self-locking nut	35 (310)
	U/T1, V/T2, W/T3	95 × 4P	70 - 150 × 4P (120 - 150 × 4P)	-	M12	Hex self-locking nut	35 (310)
	-, +1	95 × 4P	95 - 185 × 4P (185 × 4P)	-	M12	Hex self-locking nut	35 (310)
	+3	70 × 4P	35 - 95 × 4P (95 × 4P)	-	M12	Hex self-locking nut	35 (310)
	⊕	150	50 - 150 (-)	-	M12	Hex bolt (slotted)	32 - 40 (283 - 354)
4568	R/L1, S/L2, T/L3	120 × 4P	70 - 150 × 4P (150 × 4P)	-	M12	Hex self-locking nut	35 (310)
	U/T1, V/T2, W/T3	95 × 4P	70 - 150 × 4P (120 - 150 × 4P)	-	M12	Hex self-locking nut	35 (310)
	-, +1	95 × 4P	95 - 185 × 4P (185 × 4P)	-	M12	Hex self-locking nut	35 (310)
	+3	70 × 4P	35 - 95 × 4P (95 × 4P)	-	M12	Hex self-locking nut	35 (310)
	⊕	95 × 2P	60 - 150 (-)	-	M12	Hex bolt (slotted)	32 - 40 (283 - 354)
4605	R/L1, S/L2, T/L3	120 × 4P	70 - 150 × 4P (150 × 4P)	-	M12	Hex self-locking nut	35 (310)
	U/T1, V/T2, W/T3	95 × 4P	70 - 150 × 4P (120 - 150 × 4P)	-	M12	Hex self-locking nut	35 (310)
	-, +1	95 × 4P	95 - 185 × 4P (185 × 4P)	-	M12	Hex self-locking nut	35 (310)
	+3	70 × 4P	35 - 95 × 4P (95 × 4P)	-	M12	Hex self-locking nut	35 (310)
	⊕	95 × 2P	60 - 150 (-)	-	M12	Hex bolt (slotted)	32 - 40 (283 - 354)
4720	R/L1, S/L2, T/L3	120 × 4P	70 - 150 × 4P (150 × 4P)	-	M12	Hex self-locking nut	35 (310)
	U/T1, V/T2, W/T3	95 × 4P	70 - 150 × 4P (120 - 150 × 4P)	-	M12	Hex self-locking nut	35 (310)
	-, +1	95 × 4P	95 - 185 × 4P (185 × 4P)	-	M12	Hex self-locking nut	35 (310)
	+3	70 × 4P	35 - 95 × 4P (95 × 4P)	-	M12	Hex self-locking nut	35 (310)
	⊕	95 × 2P	60 - 150 (-)	-	M12	Hex bolt (slotted)	32 - 40 (283 - 354)

*1 For IP20 protection, use wires that are in the range of applicable gauges.

*2 Remove insulation from the ends of wires to expose the length of wire shown.

*3 For wire gauges more than 30 mm², tighten to a tightening torque of 4.1 N·m to 4.5 N·m (36 in·lb to 40 in·lb).

*4 Install a GFCI with this wire gauge to maintain compliance with IEC/EN 61800-5-1:2007.

*5 Terminals - and +1 have two screws. The Recommended Gauge is the wire gauge for one terminal.

*6 A junction terminal is necessary to connect a braking resistor unit (LKEB-series) to terminals B1 and B2.

■ Connect a Fuse to the Input Side (Primary Side)

The drive circuit protection must comply with IEC/EN 61800-5-1:2007 for protection against a short circuit in the internal circuitry. Yaskawa recommends connecting semiconductor protection fuses on the input side for branch circuit protection.

⚠ WARNING *Electrical Shock Hazard. After the drive blows a fuse or trips a GFCI, do not immediately energize the drive or operate peripheral devices. Wait for the time specified on the warning label at a minimum and make sure that all indicators are OFF. Then check the wiring and peripheral device ratings to find the cause of the problem. If you do not know the cause of the problem, contact Yaskawa before you energize the drive or peripheral devices. If you do not fix the problem before you operate the drive or peripheral devices, it can cause serious injury or death.*

Table 13.2 Factory-Recommended Branch Circuit Protection (200 V Class)

Drive Model	Semiconductor Protection Fuse Rated Current Manufacturer: EATON/Bussmann	Drive Model	Semiconductor Protection Fuse Rated Current Manufacturer: EATON/Bussmann
2004	FWH-45B	2082	FWH-225A FWH-250A <i>*1</i>
2006	FWH-45B	2110	FWH-225A FWH-250A <i>*1</i>
2008	FWH-45B	2138	FWH-275A FWH-300A <i>*1</i>
2010	FWH-45B	2169	FWH-275A FWH-350A <i>*1</i>
2012	FWH-50B	2211	FWH-325A FWH-450A <i>*1</i>
2018	FWH-80B	2257	FWH-600A
2021	FWH-80B	2313	FWH-800A
2030	FWH-125B	2360	FWH-1000A
2042	FWH-150B	2415	FWH-1000A
2056	FWH-200B		
2070	FWH-225A		

*1 Yaskawa recommends a fuse with a large rated current for applications with repeated loads.

Table 13.3 Factory-Recommended Branch Circuit Protection (400 V Class)

Drive Model	Semiconductor Protection Fuse Rated Current Manufacturer: EATON/Bussmann	Drive Model	Semiconductor Protection Fuse Rated Current Manufacturer: EATON/Bussmann
4002	FWH-50B	4103	FWH-275A
4004	FWH-50B	4140	FWH-300A
4005	FWH-50B	4168	FWH-325A FWH-400A <i>*1</i>
4007	FWH-60B	4208	FWH-500A
4009	FWH-60B	4250	FWH-600A
4012	FWH-60B	4302	FWH-700A
4018	FWH-80B	4371	FWH-800A
4023	FWH-90B	4414	FWH-1000A
4031	FWH-150B	4477	FWH-1200A
4038	FWH-200B	4568	FWH-1200A
4044	FWH-200B	4605	FWH-1400A FWH-1600A <i>*1</i>
4060	FWH-225A	4720	FWH-1400A FWH-1600A <i>*1</i>
4075	FWH-250A		
4089	FWH-275A		

*1 Yaskawa recommends a fuse with a large rated current for applications with repeated loads.

■ CE Standards Compliance for DC Power Supply Input

To comply with CE Standards, install a fuse for the DC power supply input.

Figure 13.3 shows a wiring example for a DC power supply that has two drives connected in parallel.

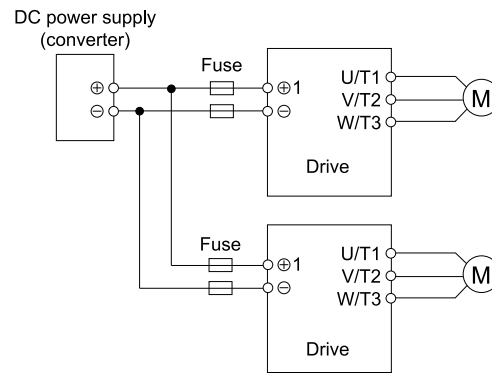

Figure 13.3 Wiring Example for DC Power Supply Input

⚠ WARNING *Electrical Shock Hazard. Do not ground the main circuit bus. Incorrect wiring can cause serious injury or death.*

Note:

- Install a fuse for each drive when operating more than one drive. If one fuse blows, replace all fuses.
- Install the external filter (system) to comply with the EMC Directive.

Refer to [Table 13.4](#) and [Table 13.5](#) for the recommended fuses.

Table 13.4 Recommended Fuse (Three-Phase 200 V Class)

Drive Model	Fuse Manufacturer: Bussmann	
	Model	Quantity
2004	FWH-45B	2
2006	FWH-45B	2
2008	FWH-45B	2
2010	FWH-45B	2
2012	FWH-50B	2
2018	FWH-80B	2
2021	FWH-80B	2
2030	FWH-125B	2
2042	FWH-150B	2
2056	FWH-200B	2
2070	FWH-250A	2
2082	FWH-250A FWH-300A <i>*1</i>	2
2110	FWH-250A FWH-275A <i>*1</i>	2
2138	FWH-300A FWH-350A <i>*1</i>	2
2169	FWH-350A FWH-450A <i>*1</i>	2
2211	FWH-450A FWH-600A <i>*1</i>	2
2257	FWH-600A FWH-700A <i>*1</i>	2
2313	FWH-800A FWH-1000A <i>*1</i>	2
2360	FWH-1000A	2
2415	FWH-1000A	2

*1 Yaskawa recommends a fuse with a large rated current for applications with repeated loads.

Table 13.5 Recommended Fuse (Three-Phase 400 V Class)

Drive Model	Fuse Manufacturer: Bussmann	
	Model	Quantity
4002	FWH-50B	2
4004	FWH-50B	2
4005	FWH-50B	2
4007	FWH-60B	2
4009	FWH-60B	2
4012	FWH-60B	2
4018	FWH-80B	2
4023	FWH-90B	2
4031	FWH-150B	2
4038	FWH-200B	2
4044	FWH-200B	2
4060	FWH-225A	2
4075	FWH-250A	2
4089	FWH-275A	2
4103	FWH-275A	2
4140	FWH-300A FWH-325A <i>*1</i>	2
4168	FWH-400A FWH-450A <i>*1</i>	2
4208	FWH-500A FWH-600A <i>*1</i>	2
4250	FWH-600A FWH-700A <i>*1</i>	2
4302	FWH-700A FWH-800A <i>*1</i>	2
4371	FWH-800A FWH-1000A <i>*1</i>	2
4414	FWH-1000A FWH-1200A <i>*1</i>	2
4477	FWH-1200A FWH-1400A <i>*1</i>	2
4568	FWH-1200A FWH-1600A <i>*1</i>	2
4605	FWH-1600A	2
4720	FWH-1600A	2

*1 Yaskawa recommends a fuse with a large rated current for applications with repeated loads.

14 China RoHS Compliance



Figure 14.1 China RoHS Mark

The China RoHS mark is displayed on products containing six specified hazardous substances that are in excess of regulatory limits, based on the “Administrative Measures for the Restriction of the Use of Hazardous Substances in Electrical and Electronic Products” and “Marking for the Restricted Use of Hazardous Substances in Electronic and Electrical Products” (SJ/T 11364-2014), which were promulgated on January 26, 2016. The number displayed in the center of the mark indicates the environment-friendly use period (number of years) in which electrical and electronic products that are being produced, sold, or imported to China can be used. The date of manufacture of the electrical and electronic product is the starting date of the environment-friendly use period for the product. The six specified hazardous substances contained in the product will not leak outside of the product during normal use within this period and will have no serious impact on the environment, the human body, or property.

The environment-friendly use period for this product is 15 years. This period is not the product warranty period.

◆ Information on Hazardous Substances in This Product

Table 14.1 shows the details on hazardous substances contained in this product.

Table 14.1 Contents of Hazardous Substances in This Product

Parts Name	Hazardous Substances					
	Lead (Pb)	Mercury (Hg)	Cadmium (Cd)	Hexavalent Chromium (Cr(VI))	Polybrominated Biphenyls (PBB)	Polybrominated Diphenyl Ethers (PBDE)
Circuit Board	×	○	○	○	○	○
Electronic Parts	×	○	○	○	○	○
Brass Screw	×	○	○	○	○	○
Aluminum Die Casting	×	○	○	○	○	○

This table has been prepared in accordance with the provisions outlined in SJ/T 11364.
 ○: Indicates that said hazardous substance contained in all of the homogeneous materials for this part is below or equal to the limit requirement of GB/T 26572.
 ×: Indicates that said hazardous substance contained in at least one of the homogeneous materials used for this part is above the limit requirement of GB/T 26572.

Note:
 This product complies with EU RoHS directives. In this table, "×" indicates that hazardous substances that are exempt from EU RoHS directives are contained.

15 对应中国RoHS指令



图 15.1 中国RoHS标志

中国RoHS标志依据2016年1月26日公布的《电器电子产品有害物质限制使用管理办法》，以及《电子电气产品有害物质限制使用标识要求》（SJ/T 11364-2014）作成。电子电气产品中特定6种有害物质的含量超过规定值时，应标识此标志。中间的数字为在中国生产销售以及进口的电子电气产品的环保使用期限（年限）。电子电气产品的环保使用期限从生产日期算起。在期限内，正常使用产品的过程中，不会有特定的6种有害物质外泄进而对环境、人和财产造成深刻影响。

本产品的环保使用期限为15年。但需要注意的是环保使用期限并非产品的质量保证期限。

◆ 本产品中含有有害物质的信息

本产品中所含有害物质的详细信息如表 15.1 所示。

表 15.1 本产品中有害物质的名称及含量

部件名称	有害物质					
	铅(Pb)	汞(Hg)	镉(Cd)	六价铬(Cr(VI))	多溴联苯(PBB)	多溴二苯醚(PBDE)
实装基板	×	○	○	○	○	○
电子元件	×	○	○	○	○	○
黄铜螺钉	×	○	○	○	○	○
铝压铸	×	○	○	○	○	○

本表格依据SJ/T 11364的规定编制。
○：表示该有害物质在该部件所有均质材料中的含量均在GB/T 26572规定的限量要求以下。
×：表示该有害物质至少在该部件的某一均质材料中的含量超出GB/T 26572规定的限量要求。
（注） 本产品符合欧盟RoHS指令。上表中的“×”表示含有欧盟RoHS指令豁免的有害物质。

16 Safe Disable Input



Figure 16.1 TUV Mark

The TUV mark identifies that the product complies with the safety standards.

This section gives precautions to support the Safe Disable input. Contact Yaskawa for more information.

The safety function complies with the standards shown in [Table 16.1](#).

Table 16.1 Applied Safety Standards and Unified Standards

Safety Standards	Unified Standards
Functional Safety	IEC/EN 61508:2010 (SIL3)
	IEC/EN 62061:2005/A2:2015 (SILCL3)
	IEC/EN61800-5-2:2016 (SIL3)
Machine Safety	ISO/EN ISO 13849-1:2015 (Cat.3, PL e)
EMC	IEC/EN 61000-6-7:2015

Note:

SIL = Safety Integrity Level.

◆ Safe Disable Specifications

The Safe Disable input provides the stop function that complies with “Safe Torque Off” as specified by IEC/EN 61800-5-2:2007. The Safe Disable input meets the requirements of EN ISO 13849-1 and IEC/EN 61508. It also has a safety status monitor to detect safety circuit errors.

When you install the drive as a component in a system, you must make sure that the system complies with the applicable safety standards.

Refer to [Table 16.2](#) for safety function specifications.

Table 16.2 Safe Disable Specifications

Item	Description
Input/Output	<ul style="list-style-type: none"> Input: 2 Safe Disable input (H1, H2) Signal ON level: 18 Vdc to 28 Vdc Signal OFF level: -4 Vdc to +4 Vdc Output: 1 MFDO safety monitor output for external device monitor (EDM)
Response time from when the input opens to when the drive output stops	3 ms or less

Item	Description
Response time from when the H1 and H2 terminal inputs open to when the EDM signal operates	20 ms or less
Failure probability	Less frequent operation request mode
	Frequent operation request mode or continuous mode
Performance level	The Safe Disable input complies with the performance level requirements of EN ISO 13849-1.
HFT (hardware fault tolerance)	N = 1
Type of subsystem	Type B

Note:

EDM = External Device Monitoring

PFD = Probability of Failure on Demand

PFH = Probability of Dangerous Failure per Hour

◆ Notes

⚠ DANGER *Sudden Movement Hazard. When you use the Safe Disable function in the safety system of a machine, do a full risk assessment for the system to make sure that all parts of the system comply with applicable safety standards. Incorrect application of the Safe Disable function can cause serious injury or death.*

⚠ DANGER *Sudden Movement Hazard. If the output circuit of the drive is damaged and the Safe Disable function turns OFF the drive output to a permanent magnet (PM) motor, the motor can rotate 180 electrical degrees. Prevent damage to equipment and injury to personnel during this condition. Sudden motor movement can cause serious injury or death. It is possible for current to flow through the motor winding in these conditions.*

⚠ DANGER *Electrical Shock Hazard. You cannot depend on the Safe Disable function to prevent electrical shock. Disconnect all power to the drive and wait for the time specified on the warning label before you remove covers. Check the drive for dangerous voltages before servicing or repair work. If you do work on the drive when it is energized and there is no cover over the electronic circuits, it can cause serious injury or death.*

⚠ WARNING *Sudden Movement Hazard. Although the Safe Disable function is in operation, gravity or other external forces in the vertical axis can move the motor. Incorrect application of the Safe Disable function can cause serious injury or death.*

⚠ WARNING *Sudden Movement Hazard. Do not use the drive output signals to control external holding brakes or dynamic brakes for functional safety. Use a system that conforms to the functional safety requirements. Incorrect application of the Safe Disable function can cause serious injury or death. Systems that use drive output signals (including EDM) for safety are not safe because drive output signals are not safety components.*

⚠ WARNING *Sudden Movement Hazard. Connect the Safe Disable inputs to the devices as specified by the safety requirements. If you connect the Safe Disable inputs incorrectly, it can cause serious injury or death.*

⚠ WARNING *Sudden Movement Hazard. To use the Safe Disable inputs, remove the jumpers between terminals H1-HC and H2-HC. If the Safe Disable circuit does not work correctly, it can cause serious injury or death.*

⚠ WARNING *Sudden Movement Hazard. Regularly examine the Safe Disable input and all other safety features. A system that does not operate correctly can cause serious injury or death.*

⚠ WARNING *Sudden Movement Hazard. Only let approved personnel who know about the drive, instruction manual, and safety standards wire, examine, and maintain the Safe Disable input. If personnel are not approved, it can cause serious injury or death.*

Note:

- Drives that have a built-in safety function must be replaced 10 years after first use.
- A maximum of 3 ms will elapse from when terminals H1 or H2 shut off until the drive switches to the "Safe Torque Off" status. Set the OFF status for terminals H1 and H2 to hold for at least 2 ms. The drive may not be able to switch to the "Safe Torque Off" status if terminals H1 and H2 are only open for less than 2 ms.
- Only use the Safe Disable Monitor (multi-function output terminal set to the EDM function) to monitor the Safe Disable status or to find a malfunction in the Safe Disable inputs. The monitor output is not a safety output.

◆ Using the Safe Disable Function

■ Safe Disable Circuit

The Safe Disable circuit has two isolated channels (terminals H1 and H2) that stop the output transistors. The input can use the internal power supply of the drive.

Set the EDM function to one of the MFDO terminals [$H2-xx = 21$ or 121] to monitor the status of the Safe Disable function. This is the “Safe Disable monitor output function”.

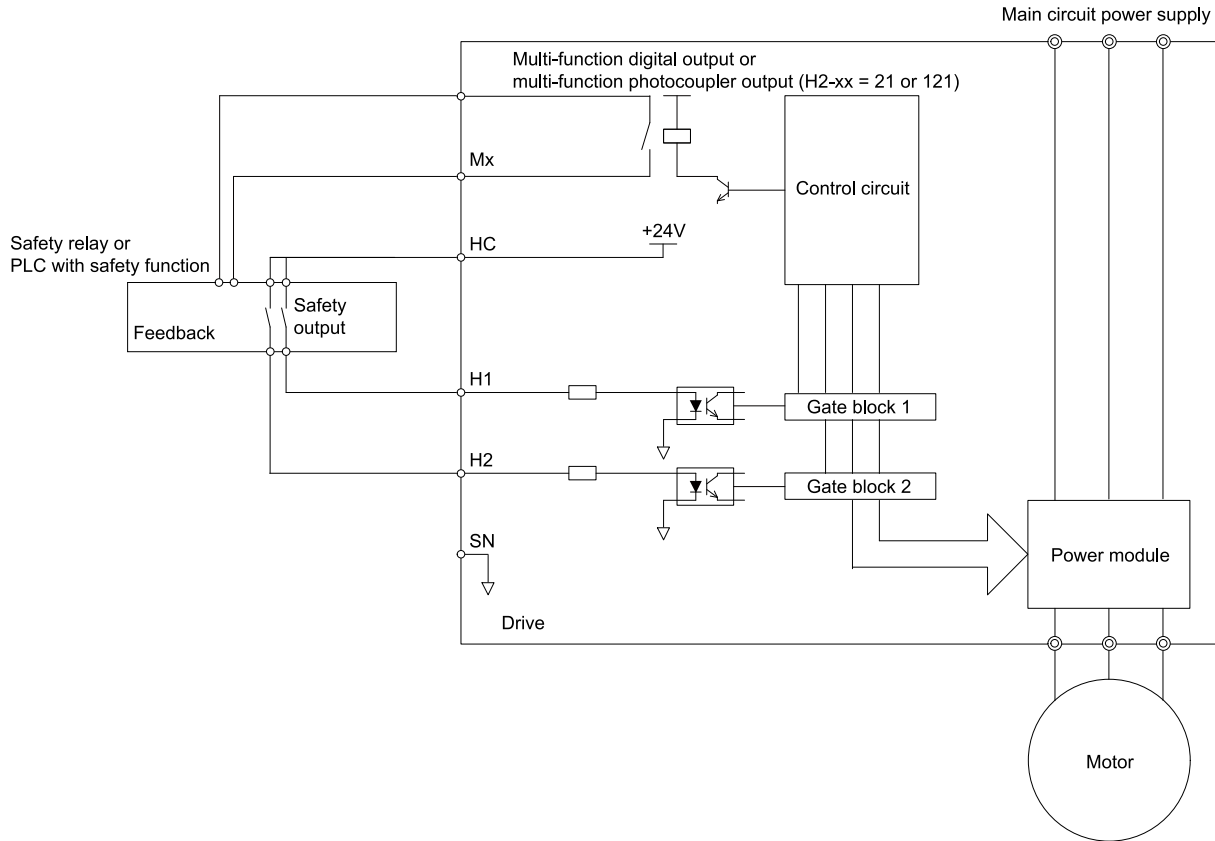

Figure 16.2 Safe Disable Function Wiring Example

■ Enabling and Disabling the Drive Output (“Safe Torque Off”)

Refer to Figure 16.3 for an example of drive operation when the drive changes from “Safe Torque Off” status to usual operation.

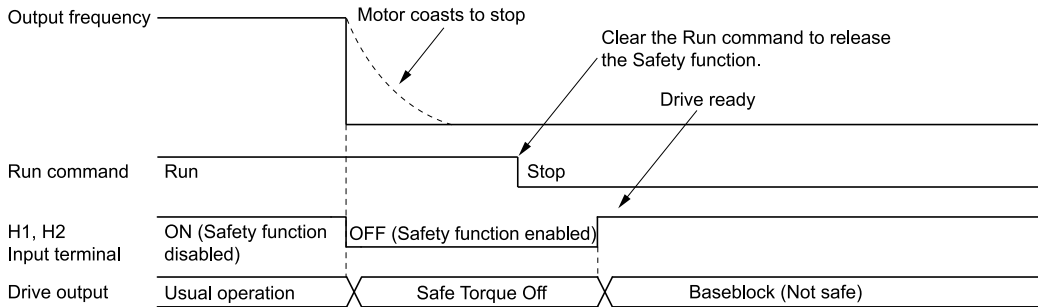

Figure 16.3 Safe Disable Operation

Switching from Usual Operation to “Safe Torque Off”

Turn OFF (open) safety input terminal H1 or H2 to enable the Safe Disable function. When the Safe Disable function is enabled while the motor is operating, the drive output and motor torque turn off and the motor always coasts to stop. The $b1-03$ [Stopping Method Selection] setting does not have an effect on the stopping method.

The “Safe Torque Off” status is only possible with the Safe Disable function. Clear the Run command to stop the drive. Turning off drive output (a baseblock condition) \neq “Safe Torque Off”.

Note:

- When it is necessary to ramp to stop the motor, do not turn off terminals H1 and H2 until the motor fully stops. This will prevent the motor from coasting to stop during usual operation.
- A maximum of 3 ms will elapse from when terminals H1 or H2 shut off until the drive switches to the “Safe Torque Off” status. Set the OFF status for terminals H1 and H2 to hold for at least 2 ms. The drive may not be able to switch to the “Safe Torque Off” status if terminals H1 and H2 are only open for less than 2 ms.

Going from “Safe Torque Off” to Usual Operation

The safety input will only release when there is no Run command.

- **During Stop**
When the Safe Disable function is triggered during stop, close the circuit between terminals H1-HC and H2-HC to disable “Safe Torque Off”. Enter the Run command after the drive stops correctly.
- **During Run**
When the Safe Disable function is triggered during run, close the circuit between terminals H1-HC and H2-HC to disable “Safe Torque Off” after clearing the Run command. Enter the Stop command, then enter the Run command when terminals H1 and H2 are ON or OFF.

■ Safe Disable Monitor Output Function and Keypad Display

Refer to [Table 16.3](#) for information about the relation between the input channel status, Safety monitor output status, and drive output status.

Table 16.3 Safe Disable Input and External Device Monitor (EDM) Terminal Status

Input Channel Status		Safety Monitor Output Status		Drive Output Status	Keypad Display	LED Status Ring	MEMOBUS Register 0020H	
Input 1 (H1-HC)	Input 2 (H2-HC)	MFDO Terminal (H2-xx = 21)	MFDO Terminal (H2-xx = 121)				bit C	bit D
ON (Close the circuit)	ON (Close the circuit)	OFF	ON	Baseblock (Drive ready)	Normally displayed	Ready: Illuminated	0	0
OFF (Open)	ON (Close the circuit)	OFF	ON	Safety status (STo)	SToF (Flashing)	ALM/ERR: Flashing	1	0
ON (Close the circuit)	OFF (Open)	OFF	ON	Safety status (STo)	SToF (Flashing)	ALM/ERR: Flashing	1	0
OFF (Open)	OFF (Open)	ON	OFF	Safety status (STo)	STo (Flashing)	Ready: Flashing	0	1

Safety Function Status Monitor

The drive Safety monitor output sends a feedback signal about the status of the Safety function. The Safety monitor output is one of the possible settings available for the MFDO terminals. If there is damage to the Safe Disable circuit, a controller (PLC or safety relay) must read this signal as an input signal to hold the “Safe Torque Off” status. This will help verify the condition of the safety circuit. Refer to the manual for the safety device for more information about the Safety function.

It is possible to switch polarity of the Safety monitor output signal with the MFDO function settings. Refer to [Table 16.3](#) for setting instructions.

Keypad Display

If the two input channels are OFF (Open), the keypad will flash *STo* [*Safe Torque OFF*].

If there is damage to the Safe disable circuit or the drive, the keypad will flash *SToF* [*Safe Torque OFF Hardware*] when one input channel is OFF (Open), and the other is ON (Short circuit). When you use the Safe disable circuit correctly, the keypad will not show *SToF*.

If there is damage to the drive, the keypad will show *SCF* [*Safety Circuit Fault*] when the drive detects a fault in the Safe disable circuit. Refer to the chapter on Troubleshooting for more information.

■ Validating the Safe Disable Function

After you replace parts or do maintenance on the drive, first complete all necessary wiring to start the drive, then test the Safe Disable input with these steps. Keep a record of the test results.

1. When the two input channels are OFF (Open), make sure that the keypad flashes *STo* [*Safe Torque OFF*], and make sure that the motor is not running.

2. Monitor the ON/OFF status of the input channels and make sure that MFDO set to the EDM function operates as shown in [Table 16.3](#).
If one or more of the these items are true, the ON/OFF status of the MFDO may not display correctly on the keypad:
 - Incorrect parameter settings.
 - A problem with an external device.
 - The external wiring has a short circuit or is disconnected.
 - There is damage to the device.Find the cause and repair the problem to correctly display the status.
3. Make sure that the EDM signal operates during usual operation as shown in [Table 16.3](#).

17 Disposal and Environmental Compatibility

- Dispose or recycle electronic waste as specified by local laws and regulations.
- Do not dispose electronic waste with household waste.

18 Maintenance

Refer to the Maintenance & Troubleshooting Manual (TOEPYAIGA8001) for more information.

Only let authorized persons do maintenance, examine, or replace components on the drive.

Read this manual carefully and know all the precautions and safety information before installing, wiring, repairing, or examining the drive or replacing components.

Examine and maintain the drive and peripheral devices regularly to extend the life of the drive and decrease performance deterioration, decrease early wear, and decrease drive failures.

Regular examinations and maintenance will also decrease system downtime.

Refer to the Technical Reference (SIEPC71061737) for more information about maintenance and examinations.

Examine the drive one time each year at a minimum.

The operating conditions, environmental conditions, and use conditions will have an effect on the examination frequency for connected equipment.

Examine the drive more frequently if you use the drive in bad conditions or in these conditions:

- High ambient temperatures
- Frequent starting and stopping
- Changes in the AC power supply or load
- Too much vibration or shock loading
- Dust, metal dust, salt, sulfuric acid, or chlorine atmospheres
- Unsatisfactory storage conditions.

The drive has Maintenance Monitors that keep track of component wear and warn maintenance period when the estimated performance life is approaching. This Maintenance Monitor eliminates the need to shut down the entire system for unexpected problems.

Users can set alarm notifications to inform the maintenance periods for a specific drive component.

19 Troubleshooting

Refer to the Maintenance & Troubleshooting Manual (TOEPYAIGA8001) for more information.

If the drive or motor do not operate correctly, look at the drive keypad for fault and alarm information.



- For drive faults:
 - The keypad shows the fault code.



-  and ALM/ERR on the LED Status Ring illuminate continuously.

- The drive shuts off output and the fault relay output activates. The motor coasts to stop.
- For drive alarms:
 - The keypad shows the alarm code.
 -  and ALM/ERR on the LED Status Ring flash.
 - Usually, the drive will continue to operate the motor. Some alarms let you select a motor stopping method.

◆ Fault Reset

1. Remove the cause of the fault or alarm.
2. While the keypad is showing the fault or alarm code, push  (RESET) or  on the keypad.

◆ Faults

This section gives information about the causes and possible solutions of faults. You must use the Fault Reset operation to remove the fault before you can operate the drive. Use the information in this table to remove the cause of the fault.

Code	Name	Causes	Possible Solutions
bAT	Keypad Battery Low Voltage	The keypad battery voltage is low.	Replace the keypad battery.
bCE	Bluetooth Communication Fault	The smartphone or tablet with DriveWizard Mobile installed is too far from the keypad.	Use the smartphone or tablet 10 m (32.8 ft) or nearer to the keypad. Note: <i>bCE</i> can occur when the smartphone or tablet is 10 m or nearer to the keypad depending on the specifications of the smartphone or tablet.
		Radio waves from a different device are causing interference with communications between the smartphone or tablet and keypad.	Make sure that no device around the keypad uses the same radio bandwidth (2400 MHz to 2480 MHz), and prevent radio interference.
boL	Braking Transistor Overload Fault	The duty cycle of the braking transistor is high (the regeneration power or repetition frequency is high).	<ul style="list-style-type: none"> • Install a braking unit (CDBR-series). • Install a regenerative converter. • Increase the deceleration time.
bUS	Option Communication Error	The drive did not receive a signal from the controller.	Correct wiring errors.
CE	Modbus Communication Error	The communications cable wiring is incorrect.	Correct wiring errors.
		There is a short circuit in the communications cable or the communications cable is not connected.	<ul style="list-style-type: none"> • Repair short circuits and connect cables. • Replace the defective communications cable.
		Electrical interference caused a communication data error.	<ul style="list-style-type: none"> • Examine the control circuit lines, main circuit lines, and ground wiring, and decrease the effects of electrical interference. • Make sure that a magnetic contactor is not the source of the electrical interference, then use a Surge Protective Device if necessary. • Use only the recommended cables or other shielded line. Ground the shield on the controller side or the drive input power side. • Separate the communication wiring from drive power lines, and install a noise filter to the input side of the power supply for communication. • Decrease the effects of electrical interference from the controller.
CF	Control Fault	Motor parameters are set incorrectly	Correctly set the motor parameters and do Auto-Tuning again.
CoF	Current Offset Fault	The drive starts operation while the induced voltage stays in the motor (during coasting to a stop or after fast deceleration).	<ul style="list-style-type: none"> • Make a sequence that does not restart operation when induced voltage stays in the motor. • Set <i>b3-01 = 1</i> [<i>Speed Search at Start Selection = Enabled</i>]. • Use <i>Speed Search from Fmax or Fref</i> [<i>H1-xx = 61, 62</i>] to do a speed search through one of the external terminals. Note: When controlling the PM motor, External Speed Search commands 1 and 2 operate the same.
CP1	Comparator 1 Limit Fault	The monitor value set in <i>H2-20</i> [<i>Comparator 1 Monitor Selection</i>] was in the range of <i>H2-21</i> [<i>Comparator 1 Lower Limit</i>] and <i>H2-22</i> [<i>Comparator 1 Upper Limit</i>].	Examine the monitor value and remove the cause of the fault.
CP2	Comparator 2 Limit Fault	The monitor value set in <i>H2-26</i> [<i>Comparator 2 Monitor Selection</i>] was not in the range of <i>H2-27</i> [<i>Comparator 2 Lower Limit</i>] and <i>H2-28</i> [<i>Comparator 2 Upper Limit</i>].	Examine the monitor value and remove the cause of the fault.

19 Troubleshooting

CPF00 to CPF03, CPF07 to CPF08, CPF11 to CPF14, CPF16 to CPF24, and CPF26 to CPF39	Control Circuit Error	A drive hardware problem occurred.	<ul style="list-style-type: none"> Re-energize the drive. If the fault stays, replace the control board or the drive. For information about replacing the control board, contact Yaskawa or your nearest sales representative.
CPF06	EEPROM Memory Data Error	The drive power supply was de-energized while a communication option card entered a parameter Write command.	Set <i>A1-03 = 2220, 3330</i> [<i>Initialize Parameters = 2-Wire Initialization, 3-Wire Initialization</i>] and initialize the drive.
CPF25	Terminal Board not Connected	The terminal board is not correctly connected to the drive.	<ol style="list-style-type: none"> De-energize the drive. Correctly connect the terminal board to the drive. Re-energize the drive.
dEv	Speed Deviation	The load is too heavy.	Decrease the load.
dv1	Z Pulse Fault	The encoder option card or the encoder on the motor side is damaged.	<ol style="list-style-type: none"> Repair wiring errors and connect disconnected wires. Correctly ground the shielded wire of the encoder cable. Re-energize the drive If the fault stays, replace the control board or the drive. For information about replacing the control board, contact Yaskawa or your nearest sales representative.
dv2	Z Pulse Noise Fault Detection	Noise interference along the encoder cable.	Isolate the encoder cable from the drive output line or a different source of electrical interference.
dv3	Inversion Detection	<i>E5-11</i> [<i>Encoder Z-Pulse Offset</i>] is set incorrectly.	Correctly set the value for $\Delta\theta$ to <i>E5-11</i> as specified by the values on the motor nameplate.
dv4	Inversion Prevention Detection	An external force on the load side rotated the motor.	<ul style="list-style-type: none"> Make sure that the motor is rotating in the correct direction. Find and repair problems on the load side that cause the motor to rotate from the load side. Disable detection of this fault for applications that rotate the motor from the load side in the opposite direction of the speed reference. The drive will not detect this fault if <i>F1-19 = 0</i> [<i>Deviation 4 Detection Selection = Disabled</i>].
		<i>E5-11</i> [<i>Encoder Z-Pulse Offset</i>] is set incorrectly.	Correctly set the value for $\Delta\theta$ to <i>E5-11</i> as specified by the values on the motor nameplate.
		There is a new encoder or the motor rotation direction changed.	Do Z Pulse Offset Tuning.
		Noise interference along the encoder cable.	Correctly ground the shielded wire of the encoder cable.
		The encoder cable is disconnected or wired incorrectly.	Examine for wiring errors or disconnected wires in the encoder cable, and repair problems.
		The drive incorrectly detected the motor magnetic pole position.	If the value for <i>U6-57</i> [<i>PolePolarityDeterVal</i>] is lower than 819, increase the value set in <i>n8-84</i> [<i>Polarity Detection Current</i>]. Consult the motor manufacturer for information about maximum setting values.
		The setting of <i>n8-84</i> [<i>Polarity Detection Current</i>] is too low.	Increase the <i>n8-84</i> setting from the default. Consult the motor manufacturer for information about maximum setting values.
		Pole Position Detection failed.	If you are using an IPM motor, do High Frequency Injection Auto-Tuning.
		The PG option card or the encoder on the motor side is damaged.	Repair the wiring and re-energize the drive, then replace the PG option card or the PG if the problem continues.
dv7	Polarity Judge Timeout	There is a disconnection in the motor coil winding.	Measure the motor line-to-line resistance and replace the motor if a coil is disconnected.
dWF1	EEPROM Memory DWEZ Data Error	There is an error in the EEPROM peripheral circuit.	<ul style="list-style-type: none"> Re-energize the drive. If the fault stays, replace the control board or the drive. For information about replacing the control board, contact Yaskawa or your nearest sales representative.
dWFL	DriveWorksEZ Fault	There was a fault in the DriveWorksEZ program.	Examine the DriveWorksEZ program and remove the cause of the fault. This is not a drive fault.
E5	MECHATROLINK Watchdog Timer Err	The drive detected a watchdog circuit exception while it received data from the controller.	<p>Examine the MECHATROLINK cable connection. If this error occurs frequently, examine the wiring and decrease the effects of electrical interference as specified by these manuals:</p> <ul style="list-style-type: none"> MECHATROLINK-II Installation Guide (MECHATROLINK Members Association, manual number MMATDEP011) MECHATROLINK-III Installation Manual (MECHATROLINK Members Association, publication number MMATDEP018)
EF0	Option Card External Fault	The communication option received an external fault from the controller.	<ol style="list-style-type: none"> Find the device that caused the external fault and remove the cause. Clear the external fault input from the controller.

EF1	External Fault (Terminal S1)	MFDI terminal S1 caused an external fault through an external device.	<ol style="list-style-type: none"> 1. Find the device that caused the external fault and remove the cause. 2. Clear the external fault input in the MFDI.
EF2	External Fault (Terminal S2)	MFDI terminal S2 caused an external fault through an external device.	<ol style="list-style-type: none"> 1. Find the device that caused the external fault and remove the cause. 2. Clear the external fault input in the MFDI.
EF3	External Fault (Terminal S3)	MFDI terminal S3 caused an external fault through an external device.	<ol style="list-style-type: none"> 1. Find the device that caused the external fault and remove the cause. 2. Clear the external fault input in the MFDI.
EF4	External Fault (Terminal S4)	MFDI terminal S4 caused an external fault through an external device.	<ol style="list-style-type: none"> 1. Find the device that caused the external fault and remove the cause. 2. Clear the external fault input in the MFDI.
EF5	External Fault (Terminal S5)	MFDI terminal S5 caused an external fault through an external device.	<ol style="list-style-type: none"> 1. Find the device that caused the external fault and remove the cause. 2. Clear the external fault input in the MFDI.
EF6	External Fault (Terminal S6)	MFDI terminal S6 caused an external fault through an external device.	<ol style="list-style-type: none"> 1. Find the device that caused the external fault and remove the cause. 2. Clear the external fault input in the MFDI.
EF7	External Fault (Terminal S7)	MFDI terminal S7 caused an external fault through an external device.	<ol style="list-style-type: none"> 1. Find the device that caused the external fault and remove the cause. 2. Clear the external fault input in the MFDI.
EF8	External Fault (Terminal S8)	MFDI terminal S8 caused an external fault through an external device.	<ol style="list-style-type: none"> 1. Find the device that caused the external fault and remove the cause. 2. Clear the external fault input in the MFDI.
Err	EEPROM Write Error	There was a problem with the EEPROM hardware.	<ul style="list-style-type: none"> • Re-energize the drive. • If the fault stays, replace the control board or the drive. Contact Yaskawa or your nearest sales representative to replace the board.
FAn1	Drive Cooling Fan Fault	The cooling fan stopped operating correctly.	<ul style="list-style-type: none"> • Examine cooling fan operation. • Re-energize the drive. • Examine U4-03 [Cooling Fan Ope Time] and U4-04 [Cool Fan Maintenance]. If the performance life of the cooling fan is expired or if there is damage to the fan, replace the fan.
FbH	Excessive PID Feedback	The <i>FbH</i> detection level is set incorrectly.	Adjust b5-36 [PID High Feedback Detection Lvl] and b5-37 [PID High Feedback Detection Time].
FbL	PID Feedback Loss	The <i>FbL</i> detection level is set incorrectly.	Adjust b5-13 [PID Feedback Loss Detection Lvl] and b5-14 [PID Feedback Loss Detection Time].
GF	Ground Fault	Overheating caused damage to the motor or the motor insulation is not satisfactory.	Measure the motor insulation resistance, and replace the motor if there is electrical conduction or unserviceable insulation.
		The motor main circuit cable is contacting ground to make a short circuit.	<ul style="list-style-type: none"> • Examine the motor main circuit cable for damage, and repair short circuits. • Measure the resistance between the motor main circuit cable and the ground terminal. If there is electrical conduction, replace the cable.
		An increase in the stray capacitance of the cable and the ground terminal caused an increase in the leakage current.	<ul style="list-style-type: none"> • If the wiring length of the cable is more than 100 m, decrease the carrier frequency. • Decrease the stray capacitance.
		There was a problem with the drive hardware.	Replace the control board or the drive. For information about replacing the control board, contact Yaskawa or your nearest sales representative.
LF	Output Phase Loss	The motor main circuit cable is disconnected.	Connect motor main circuit cable wiring. Correct wiring errors in the main circuit drive input power.
LF2	Output Current Imbalance	Phase loss occurred in the wiring on the output side of the drive.	Examine for wiring errors or disconnected wires on the output side of the drive, and repair problems.
LSo	Low Speed Motor Step-Out	The motor code set incorrectly.	<ul style="list-style-type: none"> • Set E5-01 [PM Motor Code Selection] correctly as specified by the motor. • For specialized motors, refer to the motor test report and set E5-xx correctly.
		The load is too large.	<ul style="list-style-type: none"> • Decrease the load. • Replace the drive and motor with larger capacity models.
		An external force on the load side caused the motor to move at start.	Find and repair problems on the load side that cause the motor to rotate from the load side.
		The drive incorrectly detected the motor magnetic pole position.	<ul style="list-style-type: none"> • Set b3-01 = 1 [Speed Search at Start Selection = Enabled]. • If the value for U6-57 [PolePolarityDeterVal] is lower than 819, increase the value set in n8-84 [Polarity Detection Current]. Consult the motor manufacturer for information about maximum setting values.

		The setting of n8-84 [Polarity Detection Current] is too low.	Increase the n8-84 setting from the default. Consult the motor manufacturer for information about maximum setting values.
		Incorrect values set in L8-93 [Low Speed Pull-out DetectionTime], L8-94 [Low Speed Pull-out Detect Level], and L8-95 [Low Speed Pull-out Amount].	Increase the values set in L8-93 to L8-95.
		The drive incorrectly detected the motor magnetic pole position.	If you are using an IPM motor, do High Frequency Injection Auto-Tuning.
nSE	Node Setup Error	The H1-xx = 47 [Node Setup (CANopen)] terminal was activated during run.	Stop the drive when the Node Setup function is in use.
oC	Overcurrent	The load is too large.	<ul style="list-style-type: none"> Measure the current flowing into the motor. Replace the drive with a larger capacity model if the current value is more than the drive rated current. Decrease the load or replace with a larger drive to prevent sudden changes in the current level.
		Overheating caused damage to the motor or the motor insulation is not satisfactory.	Measure the motor insulation resistance, and replace the motor if there is electrical conduction or unserviceable insulation.
		The motor main circuit cable is contacting ground to make a short circuit.	<ul style="list-style-type: none"> Examine the motor main circuit cable for damage, and repair short circuits. Measure the resistance between the motor main circuit cable and the ground terminal. If there is electrical conduction, replace the cable.
		A short circuit or ground fault on the drive output side caused damage to the output transistor of the drive.	<ul style="list-style-type: none"> Make sure that there is not a short circuit in terminal B1 and terminals U/T1, V/T2, and W/T3. Make sure that there is not a short circuit in terminals - and terminals U/T1, V/T2, and W/T3. If there is a short circuit, contact Yaskawa or your nearest sales representative.
		The acceleration time is too short.	<ul style="list-style-type: none"> Calculate the torque necessary during acceleration related to the load inertia and the specified acceleration time. Increase the values set in C1-01, C1-03, C1-05, or C1-07 [Acceleration Times] to get the necessary torque. Increase the values set in C2-01 to C2-04 [S-Curve Characteristics] to get the necessary torque. Replace the drive with a larger capacity model.
		The drive is trying to operate a specialized motor or a motor that is larger than the maximum applicable motor output of the drive.	<ul style="list-style-type: none"> Examine the motor nameplate, the motor, and the drive to make sure that the drive rated current is larger than the motor rated current. Replace the drive with a larger capacity model.
		A magnetic contactor was switched at the output.	Set the operation sequence to not turn ON or OFF the magnetic contactor while the drive is outputting voltage.
		The V/f pattern settings are incorrect.	<ul style="list-style-type: none"> Examine the ratios between the V/f pattern frequency and voltage. Decrease the voltage if it is too high compared to the frequency. Adjust E1-04 to E1-10 [V/f Pattern Parameters]. For motor 2, adjust E3-04 to E3-10.
		The torque compensation gain is too large.	Decrease the value set in C4-01 [Torque Compensation Gain] to make sure that the motor does not stall.
		Electrical interference caused a problem.	Examine the control circuit lines, main circuit lines, and ground wiring, and decrease the effects of electrical interference.
		The gain during overexcitation operation is too large.	<ul style="list-style-type: none"> Find the time when the fault occurs. If the fault occurs at the same time as overexcitation operation, decrease the value set in n3-13 [OverexcitationBraking (OEB) Gain] and consider the motor flux saturation.
		The drive received a Run command while the motor was coasting.	<ul style="list-style-type: none"> Examine the sequence and input the Run command after the motor fully stops. Set b3-01 = 1 [Speed Search at Start Selection = Enabled] or set H1-xx = 61, 62 [Speed Search from Fmax or Fref] to input speed search commands from the MFDI terminals.
		The motor code setting is incorrect for PM Control Methods.	<ul style="list-style-type: none"> Enter the correct motor code to E5-01 [PM Motor Code Selection] as specified by the PM motor. For specialized motors, refer to the motor test report and set E5-xx [PM Motor Settings] correctly.
		If the drive detects the fault at start or in the low speed range (10% or less) and n8-57 = 1 [HFI Overlap Selection = Enabled] for PM Control methods, the high frequency injection gain is too high.	<ul style="list-style-type: none"> Set E5-xx [PM Motor Parameters] correctly or do Rotational Auto-Tuning. Decrease the value of n8-41 [HFI P Gain] in 0.5 unit increments. <p>Note: Set n8-41 > 0.0 for an ordinary IPM motor.</p>
The current flowing in the motor is more than the value set in L8-27 [Overcurrent Detection Gain] for PM Control Methods.	Correct the value set in L8-27.		
The control method is set incorrectly for the motor.	Set A1-02 [Control Method Selection] correctly.		

		The motor main circuit cable is too long.	Replace the drive with a larger capacity model.
		Speed search does not complete at start when $A1-02 = 8$ [EZ Vector Control] and you use an induction motor.	When $E9-01 = 0$ [Motor Type Selection = Induction (IM)], set $b3-24 = 2$ [Speed Search Method Selection = Current Detection Speed Search].
		An overcurrent condition occurred during overexcitation deceleration.	<ul style="list-style-type: none"> Decrease the value set in $n3-13$ [OverexcitationBraking (OEB) Gain]. Decrease the value set in $n3-21$ [HSB Current Suppression Level].
oFA00	Option Not Compatible with Port	The option card connected to connector CN5-A is not compatible.	Connect the option card to the correct connector. Note: Encoder option cards are not compatible with connector CN5-A.
oFA01	Option Fault/Connection Error	The option card connected to connector CN5-A is not compatible.	<ol style="list-style-type: none"> De-energize the drive. Refer to the option card manual and correctly connect the option card to the connector on the drive.
oFA02	Duplicate Options	The same option cards or the same type of option cards are connected to connectors CN5-A, B, and C.	Connect the option card to the correct connector. Note: Use connectors CN5-C and CN5-B to connect two encoder option cards.
oFA03 to oFA06	Option Card Error Occurred at Option Port CN5-A	A fault occurred in the option card.	<ol style="list-style-type: none"> De-energize the drive. Make sure that the option card is correctly connected to the connector. If the problem continues, replace the option card.
oFA10, oFA11	Option Card Error Occurred at Option Port CN5-A	A fault occurred in the option card.	<ol style="list-style-type: none"> De-energize the drive. Make sure that the option card is correctly connected to the connector. If the problem continues, replace the option card.
oFA12 to oFA17	Option Card Connection Error (CN5-A)	A fault occurred in the option card.	<ol style="list-style-type: none"> De-energize the drive. Make sure that the option card is correctly connected to the connector. If the problem continues, replace the option card.
oFA30 to oFA43	Communication Option Card Connection Error (CN5-A)	A fault occurred in the option card.	<ol style="list-style-type: none"> De-energize the drive. Make sure that the option card is correctly connected to the connector. If the problem continues, replace the option card.
oFb00	Option Not Compatible with Port	The option card connected to connector CN5-B is not compatible.	Connect the option card to the correct connector. Note: DO-A3, AO-A3, PG-B3, and PG-X3 options can connect to connector CN5-B. Use connector CN5-C when connecting only one encoder option card.
oFb01	Option Fault/Connection Error	The option card connected to connector CN5-B was changed during operation.	<ol style="list-style-type: none"> De-energize the drive. Refer to the option card manual and correctly connect the option card to the connector on the drive.
oFb02	Duplicate Options	The same option cards or the same type of option cards are connected to connectors CN5-A, B, and C.	Connect the option card to the correct connector.
oFb03 to oFb11	Option Card Error Occurred at Option Port CN5-B	A fault occurred in the option card.	<ol style="list-style-type: none"> De-energize the drive. Make sure that the option card is correctly connected to the connector. If the problem continues, replace the option card.
oFb12 to oFb17	Option Card Error Occurred at Option Port CN5-B	A fault occurred in the option card.	<ol style="list-style-type: none"> De-energize the drive. Make sure that the option card is correctly connected to the connector. If the problem continues, replace the option card.
oFC00	Option Not Compatible with Port	The option card connected to connector CN5-C is not compatible.	Connect the option card to the correct connector. Note: AI-A3, DI-A3, and communication option cards cannot be connected to the CN5-C connector.
oFC01	Option Fault/Connection Error	The option card connected to connector CN5-C was changed during operation.	<ol style="list-style-type: none"> De-energize the drive. Refer to the option card manual and correctly connect the option card to the connector on the drive.
oFC02	Duplicate Options	The same option cards or the same type of option cards are connected to connectors CN5-A, B, and C.	Connect the option card to the correct connector.
oFC03 to oFC11	Option Card Error Occurred at Option Port CN5-C	A fault occurred in the option card.	<ol style="list-style-type: none"> De-energize the drive. Make sure that the option card is correctly connected to the connector. If the problem continues, replace the option card.

19 Troubleshooting

oFC12 to oFC17	Option Card Error Occurred at Option Port CN5-C	A fault occurred in the option card.	<ol style="list-style-type: none"> 1. De-energize the drive. 2. Make sure that the option card is correctly connected to the connector. 3. If the problem continues, replace the option card.
oFC50 to oFC55	Option Card Error Occurred at Option Port CN5-C	A fault occurred in the option card.	Refer to the manual for the PG-RT3 or PG-F3 option card.
oH	Heatsink Overheat	The ambient temperature is high and the heatsink temperature of the drive is more than the value set in L8-02 [Overheat Alarm Level].	<ul style="list-style-type: none"> • Measure the ambient temperature. • Increase the airflow in the control panel. • Install a cooling device (cooling fan or air conditioner) to lower the ambient temperature. • Remove objects near the drive that are producing too much heat.
oH1	Heatsink Overheat	The ambient temperature is high and the heatsink temperature of the drive is more than the oH1 detection level.	<ul style="list-style-type: none"> • Measure the ambient temperature. • Increase the airflow in the control panel. • Install a cooling device (cooling fan or air conditioner) to lower the ambient temperature. • Remove objects near the drive that are producing too much heat.
oH3	Motor Overheat (PTC Input)	The thermistor wiring that detects motor temperature is defective.	Correct wiring errors.
oH4	Motor Overheat Fault (PTC Input)	The motor has overheated.	<ul style="list-style-type: none"> • Check the load level, acceleration/deceleration time, and motor start/stop frequency (cycle time). • Decrease the load. • Increase the values set in C1-01 to C1-08 [Acceleration/Deceleration Times]. • Set E2-01 [Motor Rated Current (FLA)] correctly to the value specified by the motor nameplate. • Make sure that the motor cooling system is operating correctly, and repair or replace it if it is damaged. • Adjust E1-04 to E1-10 [V/f Pattern Parameters]. For motor 2, adjust E3-04 to E3-10. Decrease the values set in E1-08 [Mid Point A Voltage] and E1-10 [Minimum Output Voltage]. <p>Note: If E1-08 and E1-10 are set too low, the overload tolerance will decrease at low speeds.</p>
oL1	Motor Overload	The load is too heavy.	Decrease the load. <p>Note: Reset oL1 when U4-16 [Motor oL1 Level] < 100.</p>
		The acceleration/deceleration times or cycle times are too short.	<ul style="list-style-type: none"> • Examine the acceleration/deceleration times and the motor start/stop frequencies (cycle times). • Increase the values set in C1-01 to C1-08 [Acceleration/Deceleration Times].
		Overload occurred while running at low speed.	<ul style="list-style-type: none"> • Decrease the load when running at low speed. • Increase the motor speed. • If the motor is run frequently at low speeds, replace the motor with a larger motor or use a drive-dedicated motor. <p>Note: For general-purpose motors, overload can occur while running at low speed when operating at below the rated current.</p>
		L1-01 [Motor Overload (oL1) Protection] is set incorrectly.	Set L1-01 in as specified by the motor qualities for a drive-dedicated motor.
		The V/f pattern does not fit the motor qualities.	<ul style="list-style-type: none"> • Examine the ratios between the V/f pattern frequency and voltage. Decrease the voltage if it is too high compared to the frequency. • Adjust E1-04 to E1-10 [V/f Pattern Parameters]. For motor 2, adjust E3-04 to E3-10. Decrease the values set in E1-08 [Mid Point A Voltage] and E1-10 [Minimum Output Voltage]. <p>Note: If the values set in E1-08 and E1-10 are too low, the overload tolerance will decrease at low speeds.</p>
		E1-06 [Base Frequency] is set incorrectly.	Set E1-06 to the rated frequency shown on the motor nameplate.
		One drive is operating more than one motor.	Set L1-01 = 0 [Motor Overload (oL1) Protection = Disabled], connect thermal overload relay to each motor to prevent damage to the motor.
		The electronic thermal protector qualities and the motor overload properties do not align.	<ul style="list-style-type: none"> • Examine the motor qualities and set L1-01 [Motor Overload (oL1) Protection] correctly. • Connect a thermal overload relay to the motor.
The electronic thermal protector is operating at an incorrect level.	Set E2-01 [Motor Rated Current (FLA)] correctly to the value specified by the motor nameplate.		

		There is increased motor loss from overexcitation operation.	<ul style="list-style-type: none"> Lower the value set in <i>n3-13 [OverexcitationBraking (OEB) Gain]</i>. Set <i>L3-04 ≠ 4 [Stall Prevention during Decel ≠ Overexcitation/ High Flux]</i>. Set <i>n3-23 = 0 [Overexcitation Braking Operation = Disabled]</i>.
		The speed search-related parameters are set incorrectly.	<ul style="list-style-type: none"> Examine the settings for all speed search related parameters. Adjust <i>b3-03 [Speed Search Deceleration Time]</i>. Set <i>b3-24 = 1 [Speed Search Method Selection = Speed Estimation]</i> after Auto-Tuning.
		Phase loss in the input power supply is causing the output current to change.	Make sure that there is no phase loss, and repair problems.
		Overload occurred during overexcitation deceleration.	<ul style="list-style-type: none"> Decrease the value set in <i>n3-13 [OverexcitationBraking (OEB) Gain]</i>. Decrease the value set in <i>n3-21 [HSB Current Suppression Level]</i>.
oL2	Drive Overload	The load is too large.	Decrease the load.
		The acceleration/deceleration times or cycle times are too short.	<ul style="list-style-type: none"> Examine the acceleration/deceleration times and the motor start/ stop frequencies (cycle times). Increase the values set in <i>C1-01 to C1-08 [Acceleration/ Deceleration Times]</i>.
		The V/f pattern does not fit the motor qualities.	<ul style="list-style-type: none"> Examine the ratios between the V/f pattern frequency and voltage. Decrease the voltage if it is too high compared to the frequency. Adjust <i>E1-04 to E1-10 [V/f Pattern Parameters]</i>. Decrease the values set in <i>E1-08 [Mid Point A Voltage]</i> and <i>E1-10 [Minimum Output Voltage]</i>. For motor 2, adjust <i>E3-04 to E3-10</i>. <p>Note: If the values set in <i>E1-08</i> and <i>E1-10</i> are too low, the overload tolerance will decrease at low speeds.</p>
		The drive capacity is too small.	Replace the drive with a larger capacity model.
		Overload occurred while running at low speed.	<ul style="list-style-type: none"> Decrease the load when running at low speed. Replace the drive with a larger capacity model. Decrease the value set in <i>C6-02 [Carrier Frequency Selection]</i>.
		The torque compensation gain is too large.	Decrease the value set in <i>C4-01 [Torque Compensation Gain]</i> to make sure that the motor does not stall.
		The speed search-related parameters are set incorrectly.	<ul style="list-style-type: none"> Examine the settings for all speed search-related parameters. Adjust <i>b3-03 [Speed Search Deceleration Time]</i>. Set <i>b3-24 = 1 [Speed Search Method Selection = Speed Estimation]</i> after Auto-Tuning.
		Phase loss in the input power supply is causing the output current to change.	<ul style="list-style-type: none"> Correct errors with the wiring for main circuit drive input power. Make sure that there is no phase loss, and repair problems.
		Overload occurred during overexcitation deceleration.	<ul style="list-style-type: none"> Decrease the value set in <i>n3-13 [OverexcitationBraking (OEB) Gain]</i>. Decrease the value set in <i>n3-21 [HSB Current Suppression Level]</i>.
oL3	Overtorque Detection 1	A fault occurred on the machine. Example: The machine is locked.	Examine the machine and remove the cause of the fault.
oL4	Overtorque Detection 2	A fault occurred on the machine. Example: The machine is locked.	Examine the machine and remove the cause of the fault.
oL5	Mechanical Weakening Detection 1	The drive detected overtorque as specified by the conditions for mechanical weakening detection set in <i>L6-08 [Mechanical Fatigue Detect Select]</i> .	Do a deterioration diagnostic test on the machine side.
oL7	High Slip Braking Overload	The load inertia is too large.	<ul style="list-style-type: none"> Decrease deceleration times in <i>C1-02, C1-04, C1-06, and C1-08 [Deceleration Times]</i> for applications that do not use High Slip Braking. Use a braking resistor to decrease the deceleration time.
oPr	Keypad Connection Fault	The keypad is not securely connected to the connector on the drive.	Examine the connection between the keypad and the drive.
oS	Overspeed	There is overshoot.	<ul style="list-style-type: none"> Decrease <i>C5-01 [ASR Proportional Gain 1]</i> and increase <i>C5-02 [ASR Integral Time 1]</i>. Use <i>H6-02 to H6-05 [Pulse Train Input Setting Parameters]</i> to adjust the pulse train gain.
		There is an incorrect number of PG pulses set in the drive.	Set <i>H6-02 [Terminal RP Frequency Scaling]</i> to the pulse train frequency during 100% reference (maximum motor rotation speed).

		The oS detection level is set incorrectly.	Adjust F1-08 [Overspeed Detection Level] and F1-09 [Overspeed Detection Delay Time].
		If the drive detects the fault at start or in the low speed range (10% or less) and n8-57 = 1 [HF1 Overlap Selection = Enabled] for PM Control methods, the high frequency injection gain is too high.	<ul style="list-style-type: none"> Set E5-xx [PM Motor Parameters] correctly or do Rotational Auto-Tuning. Decrease the value of n8-41 [HF1 P Gain] in 0.5 unit increments. Note: Set n8-41 > 0.0 for IPM motors.
ov	Overvoltage	Deceleration time is too short and regenerative energy is flowing from the motor into the drive.	<ul style="list-style-type: none"> Set L3-04 = 1 [Stall Prevention during Decel = General Purpose]. Increase the values set in C1-02, C1-04, C1-06, or C1-08 [Deceleration Times]. Connect a dynamic braking option to the drive. Perform Deceleration Rate Auto-Tuning.
		The acceleration time is too short.	<ul style="list-style-type: none"> Make sure that sudden drive acceleration does not cause the fault. Increase the values set in C1-01, C1-03, C1-05, or C1-07 [Acceleration Times]. Increase the value set in C2-02 [S-Curve Time @ End of Accel]. Set L3-11 = 1 [Overvoltage Suppression Select = Enabled].
		The braking load is too large.	Connect a dynamic braking option to the drive.
		There are surge voltages in the input power supply.	Connect a DC link choke to the drive. Note: If you turn the phase advancing capacitors ON and OFF and use thyristor converters in the same power supply system, there can be surge voltages that irregularly increase the input voltage.
		The drive output cable or motor is shorted to ground (the current short to ground is charging the main circuit capacitor of the drive through the power supply).	<ol style="list-style-type: none"> Examine the motor main circuit cable, terminals, and motor terminal box, and then remove ground faults. Re-energize the drive.
		If the drive detects ov in these conditions, the speed search-related parameters are incorrect: <ul style="list-style-type: none"> During speed search During momentary power loss recovery When the drive starts again automatically 	<ul style="list-style-type: none"> Examine the settings for all speed search related parameters. Set b3-19 ≠ 0 [Speed Search Restart Attempts ≠ 0 times]. Adjust b3-03 [Speed Search Deceleration Time] setting. Do Stationary Auto-Tuning for Line-to-Line Resistance and then set b3-24 = 1 [Speed Search Method Selection = Speed Estimation].
		The power supply voltage is too high.	Decrease the power supply voltage to align with the drive rated voltage.
		The braking resistor or braking resistor unit wiring is incorrect.	Correct wiring errors in the connection to the braking resistor or braking resistor unit.
		The encoder cable is disconnected or wired incorrectly.	Examine for wiring errors or disconnected wires in the encoder cable, and repair problems.
		Electrical interference along the encoder cable.	Isolate the encoder cable from the drive output line or a different source of electrical interference.
		Electrical interference caused a drive malfunction.	<ul style="list-style-type: none"> Examine the control circuit lines, main circuit lines, and ground wiring, and decrease the effects of electrical interference. Make sure that a magnetic contactor is not the source of the electrical interference, then use a Surge Protective Device if necessary.
		The load inertia is set incorrectly.	<ul style="list-style-type: none"> Examine the load inertia settings with KEB, overvoltage suppression, or stall prevention during deceleration. Adjust L3-25 [Load Inertia Ratio] to align with the qualities of the machine.
		The Short Circuit Braking function was used in OLV/ PM control method.	Connect a braking resistor to the drive.
		There is motor hunting.	<ul style="list-style-type: none"> Adjust n1-02 [Hunting Prevention Gain Setting] settings. Adjust n2-02 [Automatic Freq Regulator Time 1] and n2-03 [Automatic Freq Regulator Time 2] settings. Adjust n8-45 [Speed Feedback Detection Gain] and n8-47 [Pull-in Current Comp Filter Time] settings.
Speed search does not complete at start when you use an induction motor in EZOLV control.	When E9-01 = 0 [Motor Type Selection = Induction (IM)], set b3-24 = 2 [Speed Search Method Selection = Current Detection 2].		
PE1, PE2	PLC Faults	The communication option detected a fault.	Refer to the manual for the communication option card.
PF	Input Phase Loss	There is a phase loss in the drive input power.	Correct errors with the wiring for main circuit drive input power.
		There is loose wiring in the drive input power terminals.	Tighten the terminal screws to the correct tightening torque.

		The drive input power voltage is changing too much.	<ul style="list-style-type: none"> Examine the input power for problems. Make the drive input power stable. If the input power supply is good, examine the magnetic contactor on the main circuit side for problems.
		There is unsatisfactory balance between voltage phases.	<ul style="list-style-type: none"> Examine the input power for problems. Make the drive input power stable. Set <i>L8-05 = 0</i> [<i>Input Phase Loss Protection Sel = Disabled</i>].
		The main circuit capacitors have become unserviceable.	<ul style="list-style-type: none"> Examine the capacitor maintenance time in monitor <i>U4-05</i> [<i>Capacitor Maintenance</i>]. If <i>U4-05</i> is more than 90%, replace the control board or the drive. For information about replacing the control board, contact Yaskawa or your nearest sales representative. If drive input power is correct and the fault stays, replace the control board or the drive. For information about replacing the control board, contact Yaskawa or your nearest sales representative.
PGo	Encoder (PG) Feedback Loss	The encoder cable is disconnected or wired incorrectly.	Examine for wiring errors or disconnected wires in the encoder cable, and repair problems.
PGoH	Encoder (PG) Hardware Fault	The encoder cable is disconnected.	Connect any disconnected wires in the encoder cable.
rF	Braking Resistor Fault	The resistance of the dynamic braking option that is connected to the drive is too low.	Use a dynamic braking option that fits the model and duty rating of the drive.
rH	Braking Resistor Overheat	The deceleration time is too short and excessive regenerative energy is flowing back into the drive.	<ul style="list-style-type: none"> Check the load level, deceleration time, and speed. Decrease the load. Increase the value set in <i>C1-02</i>, <i>C1-04</i>, <i>C1-06</i>, or <i>C1-08</i> [<i>Deceleration Times</i>]. Use a dynamic braking option that lets you use more power.
		The duty cycle is too high.	Examine the duty cycle. Note: When <i>L8-01 = 1</i> [<i>3% ERF DB Resistor Protection = Enabled</i>], the maximum braking duty cycle is 3%.
		The braking load is too large.	<ul style="list-style-type: none"> Calculate the braking load and braking power again, and decrease the braking load. Use a braking resistor that improves braking power.
		The braking resistor is not sufficient.	Use the braking resistor specifications to select a sufficient braking resistor.
rr	Dynamic Braking Transistor Fault	There is damage to the drive control circuit.	<ul style="list-style-type: none"> Re-energize the drive.
		There is a malfunction in the internal braking transistor of the drive.	<ul style="list-style-type: none"> If the fault stays, replace the control board or the drive. For information about replacing the control board, contact Yaskawa or your nearest sales representative.
SC	Short Circuit/IGBT Failure	Overheating caused damage to the motor or the motor insulation is not satisfactory.	Measure the motor insulation resistance, and replace the motor if there is electrical conduction or unserviceable insulation.
SCF	Safety Circuit Fault	The safety circuit is broken.	Replace the control board or the drive. For information about replacing the control board, contact Yaskawa or your nearest sales representative.
SEr	Speed Search Retries Exceeded	The speed search-related parameters are set incorrectly.	<ul style="list-style-type: none"> Decrease the value set in <i>b3-10</i> [<i>Speed Estimation Detection Gain</i>]. Increase the value set in <i>b3-17</i> [<i>Speed Est Retry Current Level</i>]. Increase the value set in <i>b3-18</i> [<i>Speed Est Retry Detection Time</i>]. Do Auto-Tuning again.
STPo	Motor Step-Out Detected	The motor code is set incorrectly for PM Control Methods.	<ul style="list-style-type: none"> Set <i>E5-01</i> [<i>PM Motor Code Selection</i>] correctly as specified by the motor. For specialized motors, refer to the motor test report and set <i>E5-xx</i> correctly.
SvE	Zero Servo Fault	The value set in the torque limit is too small.	Adjust torque limit-related parameters <i>L7-01</i> to <i>L7-04</i> .
TiM	Keypad Time Not Set	There is a battery in the keypad, but the date and time are not set.	Use the keypad to set the date and time.
UL3	Undertorque Detection 1	A fault occurred on the machine. Example: There is a broken pulley belt.	Examine the machine and remove the cause of the fault.
UL4	Undertorque Detection 2	A fault occurred on the machine. Example: There is a broken pulley belt.	Examine the machine and remove the cause of the fault.
UL5	Mechanical Weakening Detection 2	The drive detected undertorque as specified by the conditions for mechanical weakening detection set in <i>L6-08</i> [<i>Mechanical Fatigue Detect Select</i>].	Examine the machine for deterioration.
Uv1	DC Bus Undervoltage	There is a phase loss in the drive input power.	Correct errors with the wiring for main circuit drive input power.

Uv2	Control Power Undervoltage	The value set in <i>L2-02 [Power Loss Ride Through Time]</i> increased and the momentary power loss recovery unit is not connected to the drive.	Connect the momentary power loss recovery unit to the drive.
Uv3	Soft Charge Answerback Fault	The relay or contactor on the soft-charge bypass relay is damaged.	<ul style="list-style-type: none"> Re-energize the drive. If the fault stays, replace the control board or the drive. Check monitor <i>U4-06 [PreChargeRelay:Mainte]</i>, which shows the performance life of the soft-charge bypass relay. If <i>U4-06</i> is more than 90%, replace the board or the drive. For information about replacing the board, contact Yaskawa or your nearest sales representative.

◆ Minor Faults/Alarms

This section gives information about the causes and possible solutions when a minor fault or alarm occurs. Use the information in this table to remove the cause of the minor fault or alarm.

Code	Name	Causes	Possible Solutions
AEr	Station Address Setting Error	The node address for the communication option is not in the permitted setting range.	<ul style="list-style-type: none"> For CC-Link communication, set <i>F6-10 [CC-Link Node Address]</i> correctly. For MECHATROLINK communication, set <i>F6-20 [MECHATROLINK Station Address]</i> correctly. For CANopen communication, set <i>F6-35 [CANopen Node ID Selection]</i> correctly.
bAT	Keypad Battery Low Voltage	The keypad battery voltage is low.	Replace the keypad battery.
bb	Baseblock	An external baseblock command was entered through one of the MFDI terminals Sx, and the drive output stopped as shown by an external baseblock command.	Examine the external sequence and timing of the baseblock command input.
bCE	Bluetooth Communication Error	The smartphone or tablet with DriveWizard Mobile is too far from the keypad.	Use the smartphone or tablet within 10 m (32.8 ft) from the keypad. Note: <i>bCE</i> can occur when the smartphone or tablet is 10 m (32.8 ft) or nearer to the keypad depending on the specifications of the smartphone or tablet.
		Radio waves from a different device are causing interference with communications between the smartphone or tablet and keypad.	Make sure that no device around the keypad uses the same radio bandwidth (2400 MHz to 2480 MHz), and prevent radio interference.
boL	Braking Transistor Overload	The duty cycle of the braking transistor is high (the regeneration power or repetition frequency is high).	<ul style="list-style-type: none"> Install a braking unit (CDBR series). Install a regenerative converter. Increase the deceleration time.
bUS	Option Communication Error	The communications cable wiring is incorrect.	Correct wiring errors.
CALL	Serial Comm Transmission Error	The communications cable wiring is incorrect.	Correct wiring errors.
		There is a short circuit in the communications cable or the communications cable is not connected.	<ul style="list-style-type: none"> Repair the short-circuited or disconnected portion of the cable. Replace the defective communications cable.
		A programming error occurred on the controller side.	Examine communications at start-up and correct programming errors.
		There is damage to the communications circuitry.	<ul style="list-style-type: none"> Do a self-diagnostics check. If the problem continues, replace the control board or the drive. Contact Yaskawa or your nearest sales representative to replace the control board.
		The termination resistor setting for MEMOBUS/Modbus communications is incorrect.	On the last drive in a MEMOBUS/Modbus network, set DIP switch S2 to the ON position to enable the termination resistor.
CE	Modbus Communication Error	The communications cable wiring is incorrect.	Correct wiring errors.
		There is a short circuit in the communications cable or the communications cable is not connected.	<ul style="list-style-type: none"> Repair short circuits and connect cables. Replace the defective communications cable.
		Electrical interference caused a communication data error.	<ul style="list-style-type: none"> Examine the control circuit lines, main circuit lines, and ground wiring, and decrease the effects of electrical interference. Make sure that a magnetic contactor is not the source of the electrical interference, then use a Surge Protective Device if necessary. Use only the recommended cables or other shielded line. Ground the shield on the controller side or the drive input power side. Separate the communication wiring from drive power lines, and install a noise filter to the input side of the power supply for communication. Decrease the effects of electrical interference from the controller.
		The communication protocol is not compatible.	<ul style="list-style-type: none"> Examine the values set in <i>H5-xx</i>. Examine the settings on the controller side and correct the difference in communication conditions.

		The value set in <i>H5-09 [CE Detection Time]</i> is too small for the communications cycle.	<ul style="list-style-type: none"> Change the controller software settings. Increase the value set in <i>H5-09</i>.
		The controller software or hardware is causing a communication problem.	Examine the controller and remove the cause of the problem.
CP1	Comparator 1 Limit Error	The monitor value set in <i>H2-20 [Comparator 1 Monitor Selection]</i> was in the range of <i>H2-21 [Comparator 1 Lower Limit]</i> and <i>H2-22 [Comparator 1 Upper Limit]</i> .	Examine the monitor value and remove the cause of the error.
CP2	Comparator 2 Limit Error	The monitor value set in <i>H2-26 [Comparator 2 Monitor Selection]</i> was outside the range of <i>H2-27 [Comparator 2 Lower Limit]</i> and <i>H2-28 [Comparator 2 Upper Limit]</i> .	Examine the monitor value and remove the cause of the error.
CrST	Cannot Reset	The drive received a fault reset command when a Run command was active.	Turn off the Run command then de-energize and re-energize the drive.
CyC	MECHATROLINK CommCycleSettingErr	The communications cycle setting of the controller is not in the permitted range of the MECHATROLINK interface option.	Set the communications cycle of the controller in the permitted range of the MECHATROLINK interface option.
dEv	Speed Deviation	The load is too heavy	Decrease the load.
dnE	Drive Disabled	A terminal set for <i>H1-xx = 6A [Drive Enable]</i> turned OFF.	Examine the operation sequence.
dWAL	DriveWorksEZ Alarm	There was an error in the DriveWorksEZ program.	Examine the DriveWorksEZ program and remove the cause of the error. This is not a drive fault.
dWA2	DriveWorksEZ Alarm 2	The DriveWorksEZ program output a minor fault.	Examine the DriveWorksEZ program and remove the cause of the fault. This is not a drive fault.
dWA3	DriveWorksEZ Alarm 3	The DriveWorksEZ program output a minor fault.	Examine the DriveWorksEZ program and remove the cause of the fault. This is not a drive fault.
E5	MECHATROLINK Watchdog Timer Err	The drive detected a watchdog circuit exception while it received data from the controller.	<p>Examine the MECHATROLINK cable connection. If this error occurs frequently, examine the wiring and decrease the effects of electrical interference as specified by these manuals:</p> <ul style="list-style-type: none"> MECHATROLINK-II Installation Guide (MECHATROLINK Members Association, manual number MMATDEP011) MECHATROLINK-III Installation Manual (MECHATROLINK Members Association, publication number MMATDEP018)
EF	FWD/REV Run Command Input Error	A forward command and a reverse command were input at the same time for longer than 0.5 s.	Examine the forward and reverse command sequence and correct the problem.
EF0	Option Card External Fault	The communication option card received an external fault from the controller.	<ol style="list-style-type: none"> Find the device that caused the external fault and remove the cause. Clear the external fault input from the controller.
EF1	External Fault (Terminal S1)	MFDI terminal S1 caused an external fault through an external device.	<ol style="list-style-type: none"> Find the device that caused the external fault and remove the cause. Clear the external fault input in the MFDI.
		The wiring is incorrect.	Correctly connect the signal line to MFDI terminal S1.
		<i>External Fault [H1-01 = 2C to 2F]</i> is set to MFDI terminal S1, but the terminal is not in use.	Correctly set the MFDI.
EF2	External Fault (Terminal S2)	MFDI terminal S2 caused an external fault through an external device.	<ol style="list-style-type: none"> Find the device that caused the external fault and remove the cause. Clear the external fault input in the MFDI.
		The wiring is incorrect.	Correctly connect the signal line to MFDI terminal S2.
		<i>External Fault [H1-02 = 2C to 2F]</i> is set to MFDI terminal S2, but the terminal is not in use.	Correctly set the MFDI.
EF3	External Fault (Terminal S3)	MFDI terminal S3 caused an external fault through an external device.	<ol style="list-style-type: none"> Find the device that caused the external fault and remove the cause. Clear the external fault input in the MFDI.
		The wiring is incorrect.	Correctly connect the signal line to MFDI terminal S3.
		<i>External Fault [H1-03 = 2C to 2F]</i> is set to MFDI terminal S3, but the terminal is not in use.	Correctly set the MFDI.
EF4	External Fault (Terminal S4)	MFDI terminal S4 caused an external fault through an external device.	<ol style="list-style-type: none"> Find the device that caused the external fault and remove the cause. Clear the external fault input in the MFDI.
		The wiring is incorrect.	Correctly connect the signal line to MFDI terminal S4.
		<i>External Fault [H1-04 = 2C to 2F]</i> is set to MFDI terminal S4, but the terminal is not in use.	Correctly set the MFDI.

EF5	External Fault (Terminal S5)	MFDI terminal S5 caused an external fault through an external device.	<ol style="list-style-type: none"> 1. Find the device that caused the external fault and remove the cause. 2. Clear the external fault input in the MFDI.
		The wiring is incorrect.	Correctly connect the signal line to MFDI terminal S5.
		<i>External Fault [HI-05 = 2C to 2F]</i> is set to MFDI terminal S5, but the terminal is not in use.	Correctly set the MFDI.
EF6	External Fault (Terminal S6)	MFDI terminal S6 caused an external fault through an external device.	<ol style="list-style-type: none"> 1. Find the device that caused the external fault and remove the cause. 2. Clear the external fault input in the MFDI.
		The wiring is incorrect.	Correctly connect the signal line to MFDI terminal S6.
		<i>External Fault [HI-06 = 2C to 2F]</i> is set to MFDI terminal S6, but the terminal is not in use.	Correctly set the MFDI.
EF7	External Fault (Terminal S7)	MFDI terminal S7 caused an external fault through an external device.	<ol style="list-style-type: none"> 1. Find the device that caused the external fault and remove the cause. 2. Clear the external fault input in the MFDI.
		The wiring is incorrect.	Correctly connect the signal line to MFDI terminal S7.
		<i>External Fault [HI-07 = 2C to 2F]</i> is set to MFDI terminal S7, but the terminal is not in use.	Correctly set the MFDI.
EF8	External Fault (Terminal S8)	MFDI terminal S8 caused an external fault through an external device.	<ol style="list-style-type: none"> 1. Find the device that caused the external fault and remove the cause. 2. Clear the external fault input in the MFDI.
		The wiring is incorrect.	Correctly connect the signal line to MFDI terminal S8.
		<i>External Fault [HI-08 = 2C to 2F]</i> is set to MFDI terminal S8, but the terminal is not in use.	Correctly set the MFDI.
EP24v	External Power 24V Supply	The voltage of the main circuit power supply decreased, and the 24 V power supply is supplying power to the drive.	<ul style="list-style-type: none"> • Examine the main circuit power supply. • Turn ON the main circuit power supply to run the drive.
FbH	Excessive PID Feedback	The <i>FbH</i> detection level is set incorrectly.	Adjust <i>b5-36 [PID High Feedback Detection Lvl]</i> and <i>b5-37 [PID High Feedback Detection Time]</i> .
		There is a problem with the PID feedback wiring.	Correct errors with the PID control wiring.
		The feedback sensor is not operating correctly.	Examine the sensors on the control device side.
		A fault occurred in the feedback input circuit of the drive.	Replace the control board or the drive. For information about replacing the control board, contact Yaskawa or your nearest sales representative.
FbL	PID Feedback Loss	The <i>FbL</i> detection level is set incorrectly.	Adjust <i>b5-13 [PID Feedback Loss Detection Lvl]</i> and <i>b5-14 [PID Feedback Loss Detection Time]</i> .
HCA	High Current Alarm	The load is too heavy.	<ul style="list-style-type: none"> • Decrease the load for applications with repetitive starts and stops. • Replace the drive with a larger capacity model.
L24v	Loss of External Power 24 Supply	The voltage of the backup 24 V power supply has decreased. The main circuit power supply is operating correctly.	<ul style="list-style-type: none"> • Examine the external 24 V power supply for disconnected wires and wiring errors and repair the problems. • Examine the external 24 V power supply for problems.
LoG	Com Error / Abnormal SD card	There is not a micro SD card in the keypad.	Put a micro SD card in the keypad.
		<ul style="list-style-type: none"> • The drive is connected to USB. • The number of log communication files is more than 1000. • The micro SD card does not have available memory space. • The line number data in a log communication file was changed. • A communication error between the keypad and drive occurred during a log communication. 	Set <i>o5-01 = 0 [Log Start/Stop Selection = OFF]</i> .
LT-1	Cooling Fan Maintenance Time	The cooling fan is at 90% of its expected performance life.	<ol style="list-style-type: none"> 1. Replace the cooling fan. 2. Set <i>o4-03 = 0 [Fan Operation Time Setting = 0 h]</i> to reset the cooling fan operation time.
LT-2	Capacitor Maintenance Time	The capacitors for the main circuit and control circuit are at 90% of expected performance life.	Replace the control board or the drive. For information about replacing the control board, contact Yaskawa or your nearest sales representative.
LT-3	SoftChargeBypassRelay MainteTime	The soft charge bypass relay is at 90% of its expected performance life.	Replace the control board or the drive. For information about replacing the control board, contact Yaskawa or your nearest sales representative.
LT-4	IGBT Maintenance Time (50%)	The IGBT is at 50% of its expected performance life.	Check the load, carrier frequency, and output frequency.

oH	Heatsink Overheat	The ambient temperature is high and the heatsink temperature is more than the <i>L8-02 [Overheat Alarm Level]</i> .	<ul style="list-style-type: none"> Measure the ambient temperature. Increase the airflow around the drive. Install a cooling device (cooling fan or air conditioner) to lower the ambient temperature. Remove objects near the drive that are producing too much heat.
oH2	External Overheat (H1-XX=B)	An external device sent an <i>oH2</i> alarm.	<ol style="list-style-type: none"> Find the external device that output the overheat alarm. Remove the cause of the problem. Clear the <i>Overheat Alarm (oH2) [H1-xx = B]</i> that was sent to MFDI terminals S1 to S8.
oH3	Motor Overheat (PTC Input)	The thermistor wiring that detects motor temperature is defective.	Correct wiring errors.
oL3	Overtorque 1	A fault occurred on the machine. Example: The machine is locked.	Examine the machine and remove the cause of the fault.
oL4	Overtorque 2	A fault occurred on the machine. Example: The machine is locked.	Examine the machine and remove the cause of the fault.
oL5	Mechanical Weakening Detection 1	The drive detected overtorque as specified by the conditions for mechanical weakening detection set in <i>L6-08 [Mechanical Fatigue Detect Select]</i> .	Do a deterioration diagnostic test on the machine side.
oS	Overspeed	There is overshoot.	<ul style="list-style-type: none"> Decrease <i>C5-01 [ASR Proportional Gain 1]</i> and increase <i>C5-02 [ASR Integral Time 1]</i>. Use <i>H6-02 to H6-05 [Pulse Train Input Setting Parameters]</i> to adjust the pulse train gain.
ov	Overvoltage	There are surge voltages in the input power supply.	Connect a DC link choke to the drive. Note: If you turn the phase advancing capacitors ON and OFF and use thyristor converters in the same power supply system, there can be surge voltages that irregularly increase the input voltage.
		The drive output cable or motor is shorted to ground (the current short to ground is charging the main circuit capacitor of the drive through the power supply).	<ol style="list-style-type: none"> Examine the motor main circuit cable, terminals, and motor terminal box, and then remove ground faults. Re-energize the drive.
		The power supply voltage is too high.	Decrease the power supply voltage to align with the drive rated voltage.
		Electrical interference caused a drive malfunction.	<ul style="list-style-type: none"> Check the control circuit lines, main circuit lines, and ground wiring, and minimize the effects of noise. Check whether a magnetic contactor is the noise source, and use Surge Protective Device if necessary. Set <i>L5-01 ≠ 0 [Number of Auto-Restart Attempts ≠ 0 times]</i>.
PASS	Modbus Communication Test	The MEMOBUS/Modbus communications test is complete.	The <i>PASS</i> display will turn off after communications test mode is cleared.
PF	Input Phase Loss	There is a phase loss in the drive input power.	Correct errors with the wiring for main circuit drive input power.
		Loose wiring in the input power terminals.	Tighten the terminal screws to the correct tightening torque.
		The drive input power voltage is changing too much.	<ul style="list-style-type: none"> Examine the input power for problems. Make the drive input power stable.
		Unsatisfactory balance between voltage phases.	<ul style="list-style-type: none"> Examine the input power for problems. Make the drive input power stable. If the input power supply is good, examine the magnetic contactor on the main circuit side for problems.
		The main circuit capacitors have become unserviceable.	<ul style="list-style-type: none"> Examine the capacitor maintenance time in monitor <i>U4-05 [Capacitor Maintenance]</i>. If <i>U4-05</i> is more than 90%, replace the capacitor. Contact Yaskawa or your nearest sales representative for more information. Examine the input power for problems. Re-energize the drive. If the alarm stays, replace the circuit board or the drive. Contact Yaskawa or your nearest sales representative for more information.
PGo	Encoder (PG) Feedback Loss	The encoder cable is disconnected or wired incorrectly.	Examine for wiring errors or disconnected wires in the encoder cable, and repair problems.
PGoH	Encoder (PG) Hardware Fault	The encoder cable is disconnected.	Correct any disconnected wires in the encoder cable.
rUn	Motor Switch during Run	The drive received a <i>Motor 2 Selection [H1-xx = 16]</i> during run.	Make sure that the drive receives the Motor 2 Selection while the drive is stopped.
SE	Modbus Test Mode Error	MEMOBUS/Modbus communications self-diagnostics [<i>H1-xx = 67</i>] was done while the drive was running.	Stop the drive and do MEMOBUS/Modbus communications self-diagnostics.

STo	Safe Torque OFF	Safe Disable inputs H1-HC and H2-HC are open.	<ul style="list-style-type: none"> Make sure that the Safe Disable signal is input from an external source to terminal H1-HC and H2-HC. When the Safe Disable function is not in use, use a jumper to connect terminals H1-HC and H2-HC.
		There is internal damage to the two Safe Disable channels.	Replace the board or the drive. Contact Yaskawa or your nearest sales representative to replace the board.
SToF	Safe Torque OFF Hardware	One of the two terminals H1-HC or H2-HC received the Safe Disable input signal.	<ul style="list-style-type: none"> Make sure that the Safe Disable signal is input from an external source to terminals H1-HC or H2-HC. When the Safe Disable function is not in use, use a jumper to connect terminals H1-HC and H2-HC.
		The Safe Disable input signal is wired incorrectly.	
		There is internal damage to one Safe Disable channel.	Replace the board or the drive. Contact Yaskawa or your nearest sales representative to replace the board.
TiM	Keypad Time Not Set	There is a battery in the keypad, but you have not set the date and time.	Use the keypad to set the date and time.
TrPC	IGBT Maintenance Time (90%)	The IGBT is at 90% of its expected performance life.	Replace the IGBT or the drive. For more information, contact Yaskawa or your nearest sales representative.
UL3	Undertorque Detection 1	A fault occurred on the machine. Example: There is a broken pulley belt.	Examine the machine and remove the cause of the fault.
UL4	Undertorque Detection 2	A fault occurred on the machine. Example: There is a broken pulley belt.	Examine the machine and remove the cause of the fault.
UL5	Mechanical Weakening Detection 2	The drive detected undertorque as specified by the conditions for mechanical weakening detection set in L6-08 [Mechanical Fatigue Detect Select].	Examine the machine for deterioration.
Uv	Undervoltage	The drive input power voltage is changing too much.	<ul style="list-style-type: none"> Examine the input power for problems. Make the drive input power stable. If the input power supply is good, examine the magnetic contactor on the main circuit side for problems.

◆ Parameter Setting Errors

Parameter setting errors occur when multiple parameter settings do not agree, or when parameter setting values are not correct. Refer to the table in this section, examine the parameter setting that caused the error, and remove the cause of the error. You must first correct the parameter setting errors before you can operate the drive. The drive will not send notification signals for the faults and alarms when these parameter setting errors occur.

Code	Name	Causes	Possible Solutions
oPE01	Drive Capacity Setting Error	The value set in o2-04 [Drive Model (KVA) Selection] does not agree with the drive model.	Set o2-04 to the correct value.
oPE02	Parameter Range Setting Error	Parameters settings are not in the applicable setting range.	<ol style="list-style-type: none"> Push  to show U1-18 [oPE Fault Parameter], and find parameters that are not in the applicable setting range. Correct the parameter settings. <p>Note: If more than one error occurs at the same time, other oPExx errors have priority over oPE02.</p>
oPE03	Multi-Function Input Setting Err	The settings for these parameters do not agree: <ul style="list-style-type: none"> F3-10 to F3-25 [Terminal D1 to DF Function Selection] H1-01 to H1-08 [Terminals S1 to S8 Function Selection] H7-01 to H7-04 [Virtual Multi-Function Inputs 1 to 4] 	Correct the parameter settings.
oPE05	Run Cmd/Freq Ref Source Sel Err	The setting to assign the Run command or frequency reference to an option card or the pulse train input is incorrect.	Correct the parameter settings.
oPE06	Control Method Selection Error	A1-02 = 1, 3, or 7 [Control Method Selection = CL-V/f, CLV, CLV/PM] is set, but there is no encoder option card connected to the drive.	<ul style="list-style-type: none"> Connect an encoder option card to the drive. Set A1-02 correctly.
oPE07	Analog Input Selection Error	The settings for H3-02, H3-06, and H3-10 [MFAI Function Select] and H7-30 [Virtual Analog Input Selection] overlap.	Set H3-02, H3-06, H3-10, and H7-30 correctly to prevent overlap. <p>Note: It is possible to set these functions to multiple analog input terminals at the same time:</p> <ul style="list-style-type: none"> Setting value 0 [Frequency Reference] Setting values F and 1F [Not Used]

oPE08	Parameter Selection Error	You set a function that is not compatible with the control method set in A1-02 [Control Method Selection].	<ol style="list-style-type: none"> 1. Push  to show U1-18 [oPE Fault Parameter], and find parameters that are not in the applicable setting range. 2. Correct the parameter settings. <p>Note: If more than one error occurs at the same time, other oPExx errors have priority over oPE02.</p>
		When A1-02 = 2 [Control Method Selection = OLV], you used these parameter settings: <ul style="list-style-type: none"> • n2-02 > n2-03 [Automatic Freq Regulator Time 1 > Automatic Freq Regulator Time 2] • C4-02 > C4-06 [Torque Compensation Delay Time > Motor 2 Torque Comp Delay Time] 	<ul style="list-style-type: none"> • Set n2-02 < n2-03. • Set C4-02 < C4-06.
		When A1-02 = 0 [Control Method Selection = V/f], you used these parameter settings: <ul style="list-style-type: none"> • H6-01 = 3 [Terminal RP Pulse Train Function = Speed Feedback (V/F Control)] • H1-xx = 16 [MFDI Function Select = Motor 2 Selection] 	<p>Correct the parameter settings.</p> <p>Note: You cannot use Speed Feedback (V/F Control) with the Motor Switch function.</p>
		When A1-02 = 5 [PM Open Loop Vector], you set E5-02 to E5-07 [PM Motor Parameters] = 0.	<ul style="list-style-type: none"> • Set E5-01 [PM Motor Code Selection] correctly as specified by the motor. • For specialized motors, refer to the motor test report and set E5-xx correctly.
		When A1-02 = 5 to 7 [Control Methods for PM Motors], you used these parameter settings: <ul style="list-style-type: none"> • E5-09 = 0.0 [PM Back-EMF Vpeak (mV/(rad/s)) = 0.0 mV/(rad/s)] • E5-24 = 0.0 [PM Back-EMF L-L Vrms (mV/rpm) = 0.0 mV/min⁻¹] 	Set E5-09 or E5-24 to the correct value.
		When A1-02 = 5 to 7, you set E5-09 ≠ 0 and E5-24 ≠ 0.	Set E5-09 = 0 or E5-24 = 0.
		When A1-02 = 6 [PM Advanced Open Loop Vector], you used these parameter settings: <ul style="list-style-type: none"> • n8-57 = 0 [HFI Overlap Selection = Disabled] • You set E1-09 [Minimum Output Frequency] < the 5% value of E1-06. 	Correct the parameter settings.
		When A1-02 = 6, you set these parameters: <ul style="list-style-type: none"> • n8-35 = 0 [Initial Pole Detection Method = Pull-in] • n8-57 = 1 [Enabled] 	Correct the parameter settings.
		When A1-02 = 8 [EZOLV], you used these parameter settings: <ul style="list-style-type: none"> • E9-01 = 1, 2 [Motor Type Selection = Permanent Magnet (PM), Synchronous Reluctance (SynRM)] • b3-24 = 2 [Speed Search Method Selection = Current Detection 2] 	When E9-01 = 1 or 2, set b3-24 = 1 [Speed Estimation].
oPE09	PID Control Selection Fault	These parameters are set at the same time: <ul style="list-style-type: none"> • b5-15 ≠ 0.0 [PID Sleep Function Start Level ≠ 0.0 Hz] • b1-03 = 2, 3 [Stopping Method Selection = DC Injection Braking to Stop, Coast to Stop with Timer] 	<ul style="list-style-type: none"> • Set b5-15 ≠ 0.0. • Set b1-03 = 0, 1 [Ramp to Stop, Coast to Stop].
		These parameters are set at the same time: <ul style="list-style-type: none"> • b5-01 = 1, 2 [Standard, Standard (D on feedback)] • d2-02 ≠ 0.0 [Frequency Reference Lower Limit ≠ 0.0%] 	Correct the parameter settings.
		These parameters are set at the same time: <ul style="list-style-type: none"> • b5-01 = 1, 2 [Standard, Standard (D on feedback)] • b5-11 = 1 [PID Output Reverse Selection = Negative Output Accepted] 	Correct the parameter settings.
		These parameters are set at the same time: <ul style="list-style-type: none"> • b5-01 = 3, 4 [Fref + PID Trim, D = Fdbk, Fref + PID Trim (D on feedback)] • d2-02 ≠ 0.0 	Correct the parameter settings.

oPE10	V/f Data Setting Error	<p>The parameters that set the V/f pattern do not satisfy these conditions:</p> <ul style="list-style-type: none"> For motor 1: $E1-09 \leq E1-07 < E1-06 \leq E1-11 \leq E1-04$ [Minimum Output Frequency \leq Mid Point A Frequency $<$ Base Frequency \leq Mid Point B Frequency \leq Maximum Output Frequency] For motor 2: $E3-09 \leq E3-07 < E3-06 \leq E3-11 \leq E3-04$ [Minimum Output Frequency \leq Mid Point A Frequency $<$ Base Frequency \leq Mid Point B Frequency \leq Maximum Output Frequency] 	Set the parameters correctly to satisfy the conditions.
oPE11	Carrier Frequency Setting Error	<p>These parameters are set at the same time:</p> <ul style="list-style-type: none"> $C6-05 > 6$ [Carrier Freq Proportional Gain > 6] $C6-04 > C6-03$ [Carrier Frequency Lower Limit $>$ Carrier Frequency Upper Limit] <p>Note: When $C6-05 < 7$, $C6-04$ becomes disabled. $C6-03$ stays active.</p> <p>$C6-02$ to $C6-05$ settings are not in the applicable setting range.</p>	Set $C6-02$ to $C6-05$ correctly.
oPE13	Pulse Monitor Selection Error	$H6-06 = 101, 102, 105, \text{ or } 116$ [Terminal MP Monitor Selection = Frequency Reference, Output Frequency, Motor Speed, Output Frequency after Soft Starter] has not been set when $H6-07 = 0$ [Terminal MP Frequency Scaling = 0 Hz].	Set $H6-06$ correctly.
oPE15	Torque Control Setting Error	<p>More than one parameter is selecting torque control at the same time.</p> <ul style="list-style-type: none"> $d5-01 = 1$ [Torque Control Selection = Torque Control] $H1-xx = 71$ [MFDI Function Select = Torque Control] 	Correct the parameter settings.
oPE16	Energy Saving Constants Error	The Energy Saving parameters are not set in the applicable setting range.	Make sure that $E5-xx$ is set correctly as specified by the motor nameplate data.
oPE18	Online Tuning Param Setting Err	<p>The parameters that control online tuning are set incorrectly. In OLV control, one of these parameters was set when $n6-01 = 2$ [Online Tuning Selection = Voltage Correction Tuning]:</p> <ul style="list-style-type: none"> $E2-02$ [Motor Rated Slip] is set to 30% of the default setting or lower. $E2-06$ [Motor Leakage Inductance] is set to 50% of the default setting or lower. $E2-03 = 0$ [Motor No-Load Current = 0 A] has been set. 	Set $E2-02, E2-03, \text{ and } E2-06$ correctly.
oPE20	PG-F3 Setting Error	The value set in $F1-01$ [Encoder 1 Pulse Count (PPR)] does not agree with the number of encoder pulses.	<ul style="list-style-type: none"> Examine the $F1-01$ value and the number of encoder pulses. Set $F1-01$ correctly.
oPE33	Digital Output Selection Error	<p>These two parameters are set at the same time:</p> <ul style="list-style-type: none"> $H2-60 \neq F$ [Term M1-M2 Secondary Function \neq Not Used] $H2-01 = 1xx$ [Term M1-M2 Function Selection = Inverse output of xx] <p>These two parameters are set at the same time:</p> <ul style="list-style-type: none"> $H2-63 \neq F$ [Term M3-M4 Secondary Function \neq Not Used] $H2-02 = 1xx$ [Term M3-M4 Function Selection = Inverse output of xx] <p>These two parameters are set at the same time:</p> <ul style="list-style-type: none"> $H2-66 \neq F$ [Term M5-M6 Secondary Function \neq Not Used] $H2-03 = 1xx$ [Term M5-M6 Function Selection = Inverse output of xx] <p>These parameter pairs are set incorrectly:</p> <ul style="list-style-type: none"> $H2-21$ [Comparator 1 Lower Limit] $>$ $H2-22$ [Comparator 1 Upper Limit] $H2-27$ [Comparator 2 Lower Limit] $>$ $H2-28$ [Comparator 2 Upper Limit] 	<p>Clear the $H2-01$ to $H2-03 = 1xx$ [Inverse output of xx] settings.</p> <p>Note: It is not possible to set $H2-01$ to $H2-03 = 1xx$ [Inverse output of xx] when using output functions for logic operations ($H2-60, H2-63, H2-66 \neq F$).</p> <ul style="list-style-type: none"> Set parameters $H2-21 \leq H2-22$. Set parameters $H2-27 \leq H2-28$.

◆ Auto-Tuning Errors

This table gives information about errors detected during Auto-Tuning. If the drive detects an Auto-Tuning error, the keypad will show the error and the motor will coast to stop. The drive will not send notification signals for faults and alarms when Auto-Tuning errors occur.

Two types of Auto-Tuning errors are: *Endx* and *Erx*. *Endx* identifies that Auto-Tuning has successfully completed with calculation errors. Find and repair the cause of the error and do Auto-Tuning again, or set the motor parameters manually. You can use the drive in the application if you cannot find the cause of the *Endx* error.

Erx identifies that Auto-Tuning was not successful. Find and repair the cause of the error and do Auto-Tuning again.

Code	Name	Causes	Possible Solutions
End1	Excessive Rated Voltage Setting	The torque reference was more than 20% during Auto-Tuning or the no-load current that was measured after Auto-Tuning is more than 80%.	<ul style="list-style-type: none"> Make sure that the input motor nameplate data is correct. Do Auto-Tuning again and correctly set the motor nameplate data. If you can uncouple the motor and load, remove the motor from the machine and do Rotational Auto-Tuning again. If you cannot uncouple the motor and load, use the results from Auto-Tuning.
End2	Iron Core Saturation Coefficient	The motor nameplate data entered during Auto-Tuning is incorrect.	<ul style="list-style-type: none"> Make sure that the input motor nameplate data is correct. Do Auto-Tuning again and correctly set the motor nameplate data.
End3	Rated Current Setting Alarm	The rated current value is incorrect.	Do Auto-Tuning again and set the correct rated current shown on the motor nameplate.
End4	Adjusted Slip Calculation Error	The Auto-Tuning results were not in the applicable parameter setting range.	<ul style="list-style-type: none"> Make sure the input motor nameplate data is correct. Do Rotational Auto-Tuning again and correctly set the motor nameplate data. If you cannot uncouple the motor and load, do Stationary Auto-Tuning 2.
End5	Resistance Tuning Error	The Auto-Tuning results of the Line-to-Line Resistance were not in the applicable range.	<ul style="list-style-type: none"> Make sure that the input motor nameplate data is correct. Examine and repair damaged motor wiring.
End6	Leakage Inductance Alarm	The Auto-Tuning results were not in the applicable parameter setting range.	Make sure that the input motor nameplate data is correct, and do Auto-Tuning again.
End7	No-Load Current Alarm	The Auto-Tuning results of the motor no-load current value were not in the applicable range.	Examine and repair damaged motor wiring.
End8	HFI Alarm	<ul style="list-style-type: none"> Inductance saliency ratio (<i>E5-07/E5-06</i>) is too small. The drive cannot find the <i>n8-36 [HFI Frequency Level for L Tuning]</i> value. 	<ul style="list-style-type: none"> Set the correct value on the motor nameplate to <i>E5-xx [PM Motor Settings]</i> or do rotational/stationary Auto-Tuning. When it is necessary to set <i>n8-35 = 1 [Initial Pole Detection Method = High Frequency Injection]</i> or <i>n8-57 = 1 [HFI Overlap Selection = Enabled]</i>, make sure that there is no unusual noise in the low speed range (10% or less) and that the motor does not rotate in reverse at start. <p>Note: If the drive detects <i>End8</i>, it will automatically set <i>n8-35 = 0 [Pull-in]</i> and <i>n8-57 = 0 [Disabled]</i>. Do not change the settings unless necessary.</p>
End9	Initial Pole Detection Alarm	The drive cannot calculate the correct value for <i>n8-84 [Polarity Detection Current]</i> during High Frequency Injection Tuning.	<p>When <i>n8-35 = 1 [Initial Pole Detection Method = High Frequency Injection]</i> or <i>n8-57 = 1 [HFI Overlap Selection = Enabled]</i>, make sure that the motor does not rotate in reverse at start.</p> <p>Note: If the drive detects <i>End9</i>, it will automatically set <i>n8-35 = 0 [Pull-in]</i> and <i>n8-57 = 0 [Disabled]</i>. Do not change the settings unless necessary.</p>
Er-01	Motor Data Error	The motor nameplate data entered during Auto-Tuning is incorrect.	<ul style="list-style-type: none"> Make sure that the motor nameplate data is correct. Do Auto-Tuning again and correctly set the motor nameplate data.
Er-02	Drive in an Alarm State	The motor nameplate data entered during Auto-Tuning is incorrect.	<ul style="list-style-type: none"> Make sure that the motor nameplate data entered in Auto-Tuning is correct. Do Auto-Tuning again and correctly set the motor nameplate data.
Er-03	STOP Button was Pressed	You pushed  during Auto-Tuning.	Auto-Tuning did not complete correctly. Do Auto-Tuning again.
Er-04	Line-to-Line Resistance Error	The Auto-Tuning results were not in the applicable parameter setting range.	<ul style="list-style-type: none"> Examine and repair motor wiring. Disconnect the machine from the motor and do Rotational Auto-Tuning again.
Er-05	No-Load Current Error	The Auto-Tuning results were not in the applicable parameter setting range.	<ul style="list-style-type: none"> Examine and repair motor wiring. Disconnect the machine from the motor and do Rotational Auto-Tuning again.
Er-08	Rated Slip Error	The motor nameplate data entered during Auto-Tuning is incorrect.	<ul style="list-style-type: none"> Make sure that the input motor nameplate data is correct. Do Auto-Tuning again and correctly set the motor nameplate data.
Er-09	Acceleration Error	The motor did not accelerate for the specified acceleration time.	<ol style="list-style-type: none"> Increase the value set in <i>CI-01 [Acceleration Time 1]</i>. Disconnect the machine from the motor and do Rotational Auto-Tuning again.

Er-10	Motor Direction Error	There is defective drive and motor wiring.	Examine and repair motor wiring.
Er-11	Motor Speed Error	The torque reference during acceleration is too high (100%).	<ul style="list-style-type: none"> Increase the value set in <i>C1-01 [Acceleration Time 1]</i>. Disconnect the machine from the motor and do Rotational Auto-Tuning again.
Er-12	Current Detection Error	There is a phase loss in the drive input power. (U/T1, V/T2, W/T3)	Examine and repair motor wiring.
Er-13	Leakage Inductance Error	The motor rated current value is incorrect.	Correctly set the rated current indicated on the motor nameplate and do Auto-Tuning again.
		The drive could not complete tuning for leakage inductance in fewer than 300 s.	Examine and repair motor wiring.
Er-14	Motor Speed Error 2	The motor speed was more than two times the amplitude of speed reference during Inertia Tuning.	Decrease the value set in <i>C5-01 [ASR Proportional Gain 1]</i> .
Er-15	Torque Saturation Error	During Inertia Tuning, the output torque was more than the value set in <i>L7-01 to L7-04 [Torque Limit]</i> .	<ul style="list-style-type: none"> Increase the value set in <i>L7-01 to L7-04 [Torque Limit]</i> as much as possible. Decrease the values set for the frequency and amplitude of the test signals used when doing inertia tuning. First, decrease the test signal amplitude, and then do Inertia Tuning. If the error continues, decrease the test signal frequency and do Inertia Tuning again.
Er-16	Inertia ID Error	The inertia found by the drive was too small or too large during Inertia Tuning (10% or less, or 50000% or more).	<ul style="list-style-type: none"> Decrease the values set for the frequency and amplitude of the test signals used when doing inertia tuning. First, decrease the test signal amplitude, and then do Inertia Tuning. If the error continues, decrease the test signal frequency and do Inertia Tuning again. Correctly set the motor inertia as specified by the motor, and do Inertia Tuning again.
Er-17	Reverse Prohibited Error	<i>b1-04 = 1 [Reverse Operation Selection = Reverse disabled]</i> is set. Note: You cannot do Inertia Tuning if the drive cannot rotate the motor in reverse.	<ol style="list-style-type: none"> Enable reverse in the target machine. Set <i>b1-04 = 0 [Reverse enabled]</i>. Do Inertia Tuning again.
Er-18	Back EMF Error	The result of the induced voltage tuning was not in the applicable range.	<ol style="list-style-type: none"> Make sure that the input motor nameplate data is correct. Do Auto-Tuning again and correctly set the motor nameplate data.
Er-19	PM Inductance Error	The Auto-Tuning results of the PM motor inductance were not in the applicable range.	<ol style="list-style-type: none"> Make sure that the input motor nameplate data is correct. Do Auto-Tuning again and correctly set the motor nameplate data.
Er-20	Stator Resistance Error	The Auto-Tuning results of the PM Motor Stator Resistance were not in the applicable range.	<ol style="list-style-type: none"> Make sure that the input motor nameplate data is correct. Do Auto-Tuning again and correctly set the motor nameplate data.
Er-21	Z Pulse Correction Error	The motor is wired incorrectly.	1. Repair motor and encoder wiring errors.
		The encoder is wired incorrectly.	2. Do Z Pulse Offset Tuning again.
		You did Auto-Tuning on a coasting motor.	<ol style="list-style-type: none"> Wait for the motor to fully stop. Do Z Pulse Offset Tuning again.
		The setting for the direction of the encoder motor rotation is incorrect.	<ol style="list-style-type: none"> Set the direction of motor rotation of the encoder in <i>F1-05 [Encoder 1 Rotation Selection]</i> correctly. Do Z Pulse Offset Tuning again.
		The number of encoder pulses is incorrect.	<ol style="list-style-type: none"> Set the number of encoder pulses in <i>F1-01 [Encoder 1 Pulse Count (PPR)]</i> correctly. Do Z Pulse Offset Tuning again.
		The motor Inertia is too large.	Increase the value set in <i>n8-02 [Pole Alignment Current Level]</i> .
		Parameter <i>b1-04 = 1 [Reverse Operation Selection = Reverse Disabled]</i> and you did Z Pulse Offset Tuning.	<ul style="list-style-type: none"> If the machine prevents reverse rotation, disconnect the motor from the machinery, set <i>b1-04 = 0 [Reverse Enabled]</i>, then do Z Pulse Offset Tuning. When tuning is complete, set <i>b1-04 = 1 [Reverse Disabled]</i>. If the machine does not prevent reverse rotation, set <i>b1-04 = 0</i> and do Z Pulse Offset Tuning.
		The motor vibrates during tuning.	<ul style="list-style-type: none"> Increase the values set in <i>n8-03 [Pole Position Detection Time]</i> and <i>n8-04 [Pole Alignment Time]</i>. Decrease the value set in <i>n8-02 [Pole Alignment Current Level]</i>.
The encoder is damaged.	<ul style="list-style-type: none"> Examine the signal output from the encoder. Replace the encoder. 		

Er-25	HighFreq Inject Param Tuning Err	The motor data is incorrect.	Do Stationary Auto-Tuning again. Note: If the drive detects <i>Er-25</i> after you do Stationary Auto-Tuning, it is possible that the motor cannot use high frequency injection control. For more information, contact Yaskawa or your nearest sales representative.
-------	----------------------------------	------------------------------	---

◆ Backup Function Operating Mode Display and Errors

■ Operating Mode Display

When the drive does backup function tasks with the LCD keypad, the keypad will show the current task. These indicators do not show that an error has occurred.

Keypad Display	Name	Display	State
Drive and Keypad mismatch. Should the parameters be restored?	Detection of inconsistency between the drive and keypad	Normally displayed	The drive detected the connection of a keypad from a different drive. Select [Yes] to copy parameters backed up in the keypad to the connected drive.
Restore Restore from keypad	Restoring parameters	Flashing	The parameters stored in the keypad have been restored to the drive.
End	Backup/restore/verify operation ended normally	Normally displayed	The parameter backup, restore, or verify operation ended normally.
Backup Backup from Drive	Backing up parameters	Flashing	The parameters stored in the drive are being backed up to the keypad.
Verify Keypad & Drive	Verifying parameters	Flashing	The parameter settings stored in the keypad and the parameter settings in the drive align or are being compared.

■ Backup Function Runtime Errors

When an error occurs, the keypad shows a code to identify the error.

The table in this section shows the error codes. Refer to this table to remove the cause of the errors.

Note:

Push any key on the keypad to clear an error.

Code	Name	Causes	Possible Solutions
CPEr	Control Mode Mismatch	The keypad setting and drive setting for <i>A1-02 [Control Method Selection]</i> do not align.	1. Set <i>A1-02</i> on the drive to the same value that is on the keypad. 2. Restore the parameters.
CPyE	Error Writing Data	Parameter restore did not end correctly.	Restore the parameters.
CSEr	Control Mode Mismatch	The keypad is broken.	Replace the keypad.
dFPS	Drive Model Mismatch	You tried to restore parameters to a drive model that is different than the drive model you backed up.	1. Examine the drive model that you used to back up the parameters. 2. Restore the parameters.
iFEr	Keypad Communication Error	There was a communications error between the keypad and the drive.	Examine the connector or cable connection.
ndAT	Error Received Data	The parameter settings for model and specifications (power supply voltage and capacity) are different between the keypad and the drive.	1. Make sure that drive model and the value set in <i>o2-04 [Drive Model (KVA) Selection]</i> align. 2. Restore the parameters.
		The parameters are not stored in the keypad.	1. Connect a keypad that has the correct parameters. 2. Restore the parameters.
PWEr	DWEZ Password Mismatch	The password set in the backup operation with <i>qx-xx [DriveWorksEZ Parameters]</i> and <i>rx-xx [DriveWorksEZ Connections]</i> is incorrect.	Set the DWEZ PC software password supplied by Yaskawa for the DWEZ program user ID downloaded to the drive.
rdEr	Error Reading Data	You tried to back up when <i>o3-02 = 0 [Copy Allowed Selection = Disabled]</i> .	Set <i>o3-02 = 1 [Enabled]</i> and back up again.
vAEr	Voltage Class, Capacity Mismatch	The power supply specifications or drive capacity parameter settings are different between the keypad and the drive.	1. Make sure that drive model and the value set in <i>o2-04 [Drive Model (KVA) Selection]</i> align. 2. Restore the parameters.
vFyE	Parameters do not Match	The parameters that are backed up in the keypad and the parameters in the drive do not align.	1. Restore or backup the parameter again. 2. Verify the parameters.

Revision History

Date of Publication	Revision Number	Section	Revised Content
October 2018	1	Receiving, UL Standards	Revised current rating and fuse tables. Revised UL Standard to UL508C. YAI version.
August 2018	–	–	First Edition

GA800 Drive

Installation & Primary Operation

YASKAWA AMERICA, INC.

2121, Norman Drive South,
Waukegan, IL 60085, U.S.A.
+1-800-YASKAWA (927-5292)
<http://www.yaskawa.com>

DRIVE CENTER (INVERTER PLANT)

2-13-1, Nishimiyaichi, Yukuhashi,
Fukuoka, 824-8511, Japan
Phone: +81-930-25-2548
<http://www.yaskawa.co.jp>

YASKAWA EUROPE GmbH

Hauptstr. 185, 65760 Eschborn,
Germany
Phone: +49-6196-569-300
E-mail: support@yaskawa.eu.com
<http://www.yaskawa.eu.com>

YASKAWA ELÉTRICO DO BRASIL LTDA.

777, Avenida Piraporinha,
Diadema, São Paulo, 09950-000,
Brasil
Phone: +55-11-3585-1100
<http://www.yaskawa.com.br>

In the event that the end user of this product is to be the military and said product is to be employed in any weapons systems or the manufacture thereof, the export will fall under the relevant regulations as stipulated in the Foreign Exchange and Foreign Trade Regulations. Therefore, be sure to follow all procedures and submit all relevant documentation according to any and all rules, regulations and laws that may apply.

Specifications are subject to change without notice for ongoing product modifications and improvements.

Original instructions.

© 2018 YASKAWA Electric Corporation

YASKAWA ELECTRIC CORPORATION



TOEPC71061737

TOEPC71061737
Revision: B <1>-YAI
October 2018
Published in U.S.A.
17-4-18_YAI

YASKAWA